

BIODIESEL PRODUCTION FROM RICE BRAN OIL OVER MODIFIED NATURAL ZEOLITE CATALYST

Arif Hidayat^{1*}, Nur Indah Fajar Mukti¹, Bagus Handoko¹, Bachrun Sutrisno¹

¹*Department of Chemical Engineering, Faculty of Engineering, Universitas Islam Indonesia, Jalan Kaliurang Km 14,5, Yogyakarta 55584, Indonesia*

(Received: December 2017 / Revised: January 2018 / Accepted: February 2018)

ABSTRACT

The purpose of this study is to develop natural zeolite impregnated with potassium nitrate (KNO₃) as a heterogenous catalyst for the transesterification of rice bran oil (RBO) in order to produce Fatty Acid Methyl Ester (FAME). We conducted the Nitrogen adsorption-desorption method, Fourier Transform Infra-Red (FT-IR) spectrometer, and X-Ray Diffraction (XRD) analysis in order to characterize the physicochemical properties of the modified natural zeolite catalysts. We investigated the influences of RBO to methanol mole ratio in the range of 1:6 to 1:12. The variation of natural zeolite catalyst amount performed, also, at 1, 2.5, 5 and 10 wt. % of RBO. Moreover, the reaction temperatures were varied at room temperature (32°C), 60°C and 67.5°C. The highest biodiesel yield was 83.2% which was obtained at a ratio of 1:12 RBO to methanol mole, an amount of modified natural zeolite catalyst of 10 wt.% of RBO and a reaction temperature of 67.5°C. In order to study the reusability of modified natural zeolite catalyst, three successive transesterification reactions were carried out using the same reaction conditions.

Keywords: Biodiesel; Catalyst; Natural zeolite; Potassium; Rice bran oil (RBO)

1. INTRODUCTION

Biodiesel is an alternative fuel that contains long chain fatty acids mono alkyl ester. The raw materials, used in producing biodiesel, originate from natural sources i.e. vegetable oils or animal fat (Pradana et al., 2017). Biodiesel can replace fossil fuels in conventional diesel engines. Biodiesel is predominantly a renewable, clean burning fuel that is environmentally friendly, non-toxic, and free from harmful sulphur (Chen et al., 2011). Biodiesel synthesis can be carried out by either the esterification of fatty acids or the transesterification process of triglycerides contained in the raw materials.

The cost of production process is a major constraint related to the commercialization of biodiesel production. The use of low cost feedstock is an alternative way of improving the economic value of biodiesel production and its commercial production industry scale. Rice bran oil (RBO) is the vegetable oil that has the potential as a low cost feedstock for biodiesel production. RBO was obtained from rice milling. The extraction of the hard outer brown layer of rice after rice husk is the process used to generate RBO. Approximately the RBO content in rice bran is 15–23% of weight which is determined from the type of rice and milling process. As an agricultural country, Indonesia has the potential to generate annually RBO on a large scale. In 2016, Indonesia produced about 75 million tons of rice bran with a potential of yielding 15 million tons of RBO. Due to the high oil content, it is proposed that RBO has the prospect of becoming a predominant

*Corresponding author's email: arif.hidayat@uii.ac.id, Tel. +62-274-895287, Fax. +62-274-895007
Permalink/DOI: <https://dx.doi.org/10.14716/ijtech.v9i2.1084>

low-cost feedstock for Indonesian biodiesel production. Conventionally, by using either transesterification or the esterification process, the homogeneous base or acid catalysts are employed in biodiesel production. However, there are many obstacles to using homogeneous catalysts for biodiesel production; these are such as the need for a further product separation process, the catalysts are used only once, and they produce hazardous waste. Therefore, in order to overcome the problems, there has been widespread reporting of heterogeneous catalysts being an alternative procedure in biodiesel production (Yusuff et al., 2018). The heterogeneous catalysts have many advantages i.e. easy separation from the biodiesel product (Takagaki, et al., 2006), reusability (Mardhiah et al., 2017) and generation of harmless waste (Alonso et al., 2007).

There have been reports about a number of solid catalysts in relation to their transesterification reactions. These are such as calcium lanthanum/CaO–La₂O₃ mixed oxide catalyst (Taufiq-Yap et al., 2014), anion exchange resin (Jaya et al., 2015), Li–Al mixed oxide catalyst/LiAlO₂ (Dai et al., 2015), ZrMgAl hydrotalcites (Nowicki et al., 2016), Na/Zr-SBA-15 (Chen et al., 2014), KOH/ZSM₅ (Saba et al., 2016), Ce/Mn oxide catalyst (Nasreen et al., 2016), strontium-doped CaO/MgO catalyst (Sudsakorn et al., 2017), tetraalkylammonium hydroxide-functionalized SBA-15 materials (Xie & Fan, 2014), Amine-functionalized MCM-41 catalysts (de Lima et al., 2014), sugarcane bagasse (Augustia et al., 2018), coconut shell biochar (Hidayat et al., 2015, Hidayat et al., 2016), rice husk ash (Hidayat & Sutrisno, 2017) and tin catalysts (Shah et al., 2014).

Natural zeolite, which is an abundant and low-cost resource, is a type of frame-structured hydrated aluminosilicate mineral. The structures of natural zeolites consist of three-dimensional frameworks of SiO₄ and AlO₄ tetrahedral. Commonly, in many industries, zeolites have been applied as either ion-exchange resin or wastewater treatment or molecular sieve or solid catalyst. As catalysts, Zeolites have the characteristics of acidic sites and shape selectivity. Due to its porous structure, the ability for small molecules such as triglycerides to enter the inner structure, chemical and thermal stability and relatively low cost, the natural zeolite can be utilized as a solid catalyst for biodiesel synthesis.

There have been studies of utilizing zeolite as a catalyst for biodiesel production through using different types of feedstock such as sunflower oil, soybean oil and palm oil. Al-Jammal et al. (2016) tested zeolite tuft for transesterification reaction of sunflower oil. After 2 hours, the highest yield of biodiesel was 96.7% which was obtained under the following reaction conditions: 1:11.5 oil to methanol mole ratio and 50°C reaction temperatures. In another report, Wu et al. (2013) prepared various types of CaO catalysts, supported by NaZSM-5, KL and NaY zeolites, for the purpose of catalyzing the transesterification reaction of soybean oil. The result showed that the biodiesel yield was 95% under the optimal conditions, namely, 1:9 oil to methanol mole ratio, 3 wt.% catalyst amounts, 65°C reaction temperature and 3 hours reaction time. By using palm oil as feedstocks, Kusuma et al. (2013) tested KOH/natural zeolite for transesterification reaction. The required amount of catalyst was 3 wt.% to reach the maximum biodiesel yield of 97.02% after 3 hours with a reaction temperature of 60°C and palm oil to methanol of 1:7.

Besides technical aspects, the economic analysis plays the important role in determining the feasibility of the biodiesel plant. Also, different authors conducted economic analyses of several biodiesel productions. The numerous selection criteria, which were proposed to determine the economic viability of biodiesel commercialization, were total capital cost (Zhang et al., 2003), net present value (Marchetti & Errazu, 2008), biodiesel break-even price (You et al., 2008) and the rate of return after tax (West et al., 2008). Economic analysis provides a better understanding of the commercialization of biodiesel production and provides, also, a very useful tool to predict limits of economic feasibility.

This research study, we used the transesterification reactions of RBO from potassium nitrate (KNO_3) to support natural zeolite. This study offers the simple preparation procedure to synthesis heterogeneous catalysts by using natural zeolite as a catalyst support because of its abundant availability and low price. The catalysts' activities were tested by varying the RBO to methanol mole ratio, reaction temperatures and the amount of natural zeolite catalyst. The use of RBO gives, also, an alternative resource raw material for biodiesel production.

2. METHODOLOGY

2.1. Catalyst Preparation

We sieved the natural zeolite support into particles with diameters between 150 and 200 mesh and refluxed them with 0.5 M H_2SO_4 solution at 90°C for 4 hours. The H_2SO_4 solution can modify the porous structures and can increase the internal surface area so that it provides more sites on the surface of the natural zeolite surface for occupation by the active metals. Then, we washed the natural zeolite with distilled water to neutralize the materials. Thereafter, we dried the activated natural zeolite in the oven overnight at 110°C . We purchased the metal salts, Potassium nitrate (KNO_3), from E. Merck (Germany). In order to prepare the catalyst, we applied the incipient wetness impregnation technique to the potassium metals on the natural zeolite surface. We conducted the impregnation methods as follows: a certain amount of natural zeolite was mixed with a KNO_3 metal salt solution. Then, the mixture was stirred vigorously for 24 hours at ambient temperature. Thereafter, the mixture was filtered and the prepared catalyst was calcined in a muffle furnace at 400°C for 4 hours. The natural zeolites, which were activated and continued with potassium impregnation, were labelled as the K/NZ catalysts.

2.2. Catalyst Characterization

We characterized the natural zeolite and K/NZ catalyst porosity by using nitrogen adsorption-desorption isotherm at 77.35 K in order to determine the BET surface area, total pore volume and average pore diameter. We determined the content of the potassium metal on the K/NZ catalysts by using Atomic Absorption Spectroscopy (AAS). We analyzed the functional groups on the surface of the materials by using the Fourier-transform infrared spectroscopy (FT-IR). X-Ray Diffraction (XRD) technique. This was carried out to confirm the crystalline structure.

2.3. Activity Test

As shown in Figure 1, the K/NZ catalyst was tested for the transesterification reaction of the RBO by using a 500 mL three-necked round bottom flask as a batch reactor. Initially, we poured the methanol into the reactor and mixed it with the K/NZ catalyst. The reactor was placed in a water bath on a hot plate magnetic stirrer equipped with a reflux condenser. We used a thermometer to measure the temperature. Then, the mixture was heated up to 60°C . When the mixture reached this temperature, the RBO was introduced into the reactor which was stirred vigorously to ensure that the mixture was uniform. The reaction temperature was maintained at 60°C during reaction. After a certain time, the reaction was stopped and the K/NZ catalyst was separated from the reaction liquid product by filtering. The liquid product was placed into a funnel in order to separate the methyl ester and glycerol. Under atmospheric temperature, both two phases appeared after 12 hours of separation. The methyl ester was in the upper layer and the glycerol was in the lower layer. Subsequently the distilled water was used to wash the methyl ester and to remove the remaining methanol and glycerol. Finally, any traces of water in the product were removed by heating in the oven for 8 hours at 110°C . In this study, we investigated the effects of RBO to methanol mole ratio, temperature, and catalyst amount were investigated. We used the following equation to determine the yield of biodiesel by:

$$yield(\%) = \frac{\text{weight of biodiesel} \times \text{total \% of biodiesel product}}{\text{weight of RBO}} \times 100\% \quad (1)$$

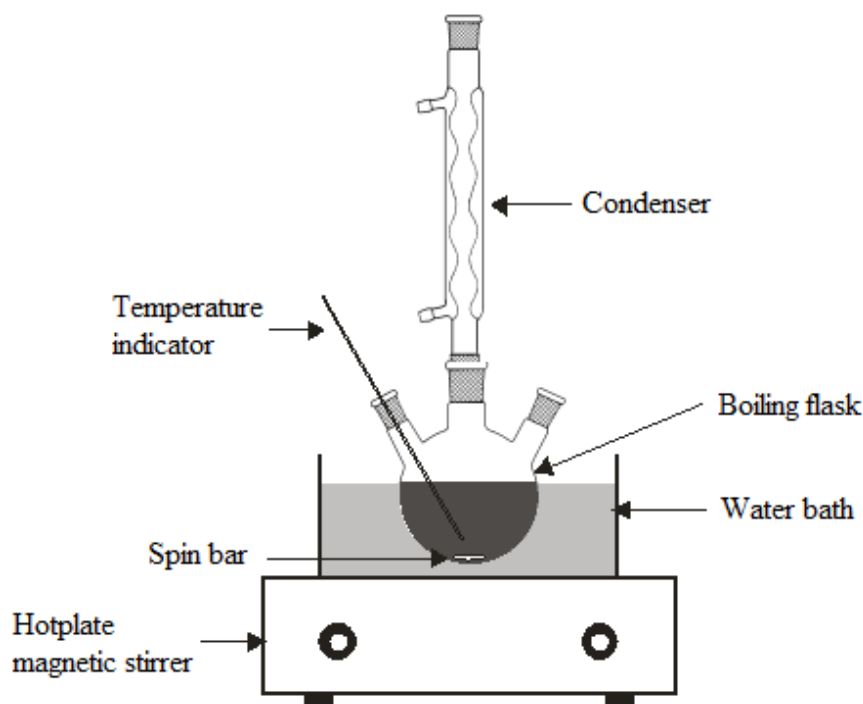

Figure 1 Experiment set-up and apparatus for transesterification reaction of RBO

2.4. Economic Analysis

We conducted an Economic analysis to determine whether or not the project was economically feasible. The Net Present Value (NPV) and Internal Rate of Return (IRR) were evaluated in order to decide the project's feasibility. The calculation of the NPV was based on the difference of present values between the outgoing and incoming cash flows over a certain period of time. Accordingly, the NPV was calculated as follows:

$$NPV = \sum_{i=0}^n \frac{C_i}{(1+r)^i} - C_0 \quad (2)$$

where, C_0 is the capital investment, r is the Internal Rate of Return (IRR) and C_i is the cash flow in the i th year, n being the lifetime years.

3. RESULTS AND DISCUSSION

3.1. Effect of Inlet Air Temperature

We tested the physico-chemical characteristics of material, including the natural zeolite and K/NZ catalyst by using N_2 adsorption–desorption isotherm, FT-IR spectra and XRD technique. We conducted the N_2 adsorption–desorption isotherm analysis of the raw natural zeolite, activated natural zeolite and K/NZ catalyst in order to determine the BET surface area, total pore volume, and average pore size. Table 1 presents the results. We concluded that the lowest BET surface area was found on the raw natural zeolite ($34.64 \text{ m}^2 \cdot \text{g}^{-1}$). After acid treatment, the BET surface area was increased to $213.42 \text{ m}^2/\text{g}$ due to the opening of the natural zeolite's internal pores. As well as the BET surface area, after activation from using acid solution, the total pore volume of natural zeolite increased from 0.1020 to $0.1994 \text{ cm}^3 \cdot \text{g}^{-1}$. On the other hand, the reduction of average pore size diameter occurred from 11.78 to 3.74 nm . We used the impregnation technique to attach the Potassium metal to the surface of the natural zeolite. The

attachment of Potassium metals to the surface of the catalyst was intended to form an active site which served to accelerate the reaction. After preparing the catalyst by impregnation, the surface area and total pore volume reduced to $111.56 \text{ m}^2/\text{g}$ and $0.0789 \text{ cm}^3 \cdot \text{g}^{-1}$ respectively. Meanwhile, the K/NZ catalyst's average pore size diameter increased to 8.28 nm . The reactant molecules would have easy access to the internal catalyst when there was, on average, a large sized pore size diameter.

Table 1 Characteristics of raw natural zeolite, activated natural zeolite and K/NZ catalyst

Sampel	BET surface area ($\text{m}^2 \cdot \text{g}^{-1}$)	pore size (nm)	total pore volume ($\text{cm}^3 \cdot \text{g}^{-1}$)
Raw natural zeolite	34.64	11.78	0.1020
Activated natural zeolite	213.42	3.74	0.1994
K/NZ catalyst	111.56	8.28	0.0789

We used the X-Ray Diffraction (XRD) analysis to evaluate respectively the crystalline structure of activated natural zeolite and K/NZ catalyst. Figures 2a and 2b show the results of the XRD analysis of the activated natural zeolite and the K/NZ catalyst.

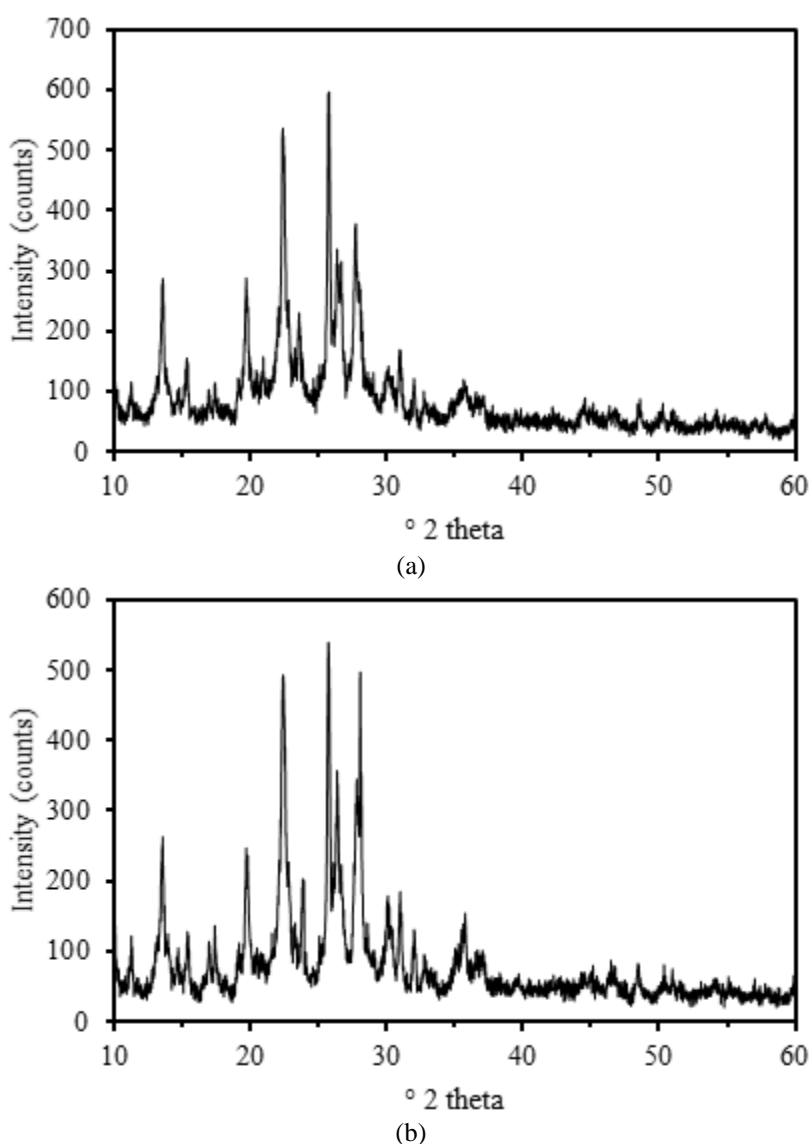

Figure 2 XRD pattern of: (a) activated natural zeolite; and (b) K/NZ catalyst

The XRD pattern of activated natural zeolite exhibits the typical diffraction peaks of zeolite at Bragg angle (2θ)=12.4°; 19.4°; 29.9°; 37.1°; 45°; 56°; and 60.6°. The pattern indicates, also, that the natural zeolite, used in this study, was grouped into a mordenite type. The K/NZ catalyst displayed a new phase of Potassium oxide (K_2O) species in $2\theta = 31^\circ$; 39° ; 51° and 55° which corresponded to (1 1 7), (2 2 0), (6 3 1), and (7 2 0) planes. The K_2O species was formed during the calcination process. Kusuma et al. (2013) indicated that the K_2O 's contribution was to increase catalytic activity during the transesterification reaction due to it providing the basicity of a solid surface.

We determined the Potassium content in the activated natural zeolite and the K/NZ catalyst by using Atomic Absorption Spectroscopy (AAS) and the results for the modified zeolite and the K/NZ catalyst were 0.34% (weight) and 4.76%, respectively. The result showed that the Potassium content on the modified zeolite increased after its impregnation with KNO_3 . This indicated that, during the impregnation process, the Potassium molecules were attached or incorporated into zeolite structure or matrix.

Figure 3 compares the FTIR spectra of the activated natural zeolite and the K/NZ catalyst. The FT-IR spectra showed a band at 1640 cm^{-1} which were attributed to the scissor vibrations in water molecule as shown in Figure 3. The asymmetric and symmetric stretching vibrations on wavelength of 706 and 1050 cm^{-1} corresponded to SiO_4 and AlO structures respectively. The aim of the activation of the raw natural zeolite was to eliminate the mineral impurities on the internal pores of materials and to reduce the content of aluminum (Al) in the framework (dealumination). The dealumination could result in the active sites that had high acid strength. The wavenumber on 1041 to 1080 cm^{-1} indicated the shifted asymmetric stretching vibration of Si-O-Al. Due to the Al framework being reduced to become the Al non framework (dealumination), the wavenumber shifted to a larger band. It caused, also, the zeolite's internal pore to be more open and clean from impurities. The band at 550 cm^{-1} was associated to the deformation vibration of Al-O-Si group. The stretching of the zeolitic structure's hydroxyl groups was shown at the broad peak on $3400\text{--}3700\text{ cm}^{-1}$. Meanwhile, the intensity of the O-H stretching vibration (3464 cm^{-1}) and O-H bending vibration (1635 cm^{-1}) declined after the activation.

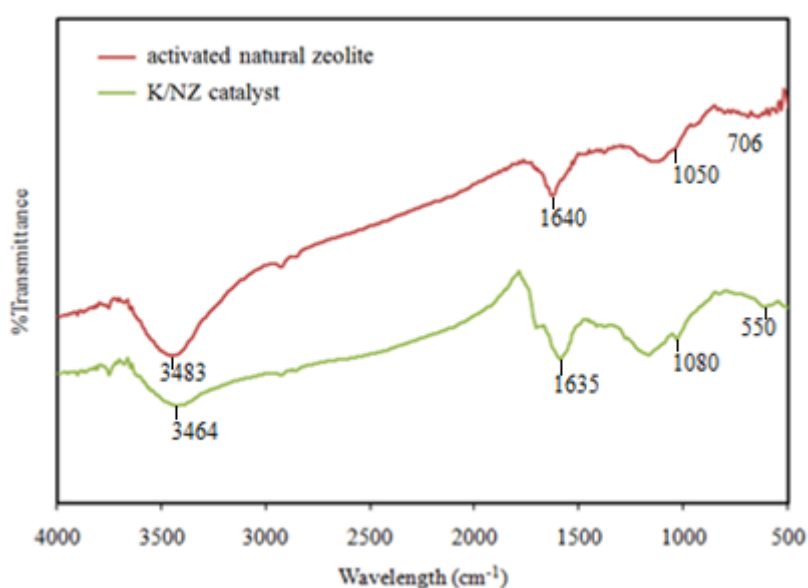

Figure 3 The FT-IR spectra of activated natural zeolite and K/NZ catalyst

3.2. Transesterification Reaction

3.2.1. Effect of reaction temperature

We tested the K/NZ catalyst for transesterification reaction by using methanol and RBO as feedstock. We conducted the transesterification reaction by using three different reaction temperatures to study the effect of reaction temperatures on biodiesel yield. Figure 4 presents the results. As can be seen in Figure 4, the reaction temperatures affected the biodiesel yield. When the reaction temperature was elevated from room temperature (32°C) to 60°C, the biodiesel yield increased from 46.8% to 82.6%. It can be explained that the increased reaction temperature accelerated the rate of reaction and increased the biodiesel yield. There was, also, a further increase in the reaction temperature to methanol reflux temperature (67.5°C) whereby the biodiesel yield increased slightly to 83.2%. A slight increase in biodiesel yield was due to the reflux conditions which formed the vapor phase. This caused the rate of reaction rate to be constant due to the effect of mass transfer. The increasing of the reaction temperature reduced the oil's viscosity and resulted in better mixing of oil with methanol and the separation of glycerol from biodiesel occurred faster.

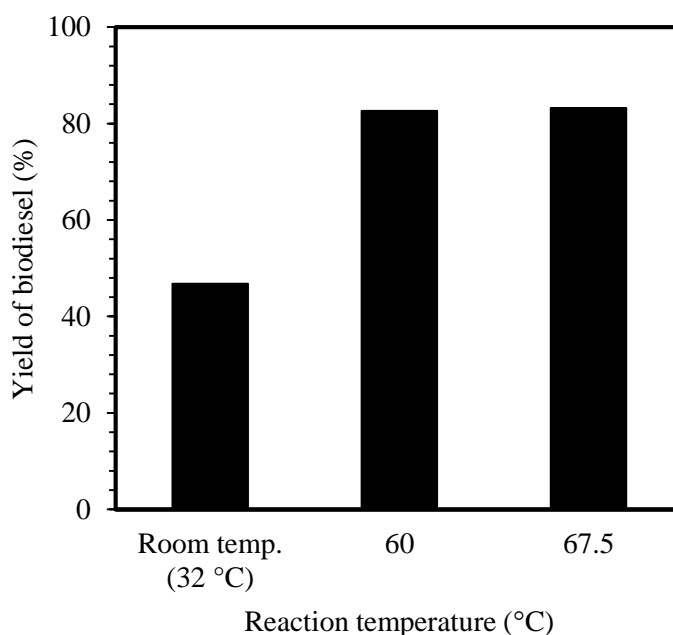

Figure 4 The effect of reaction temperature on the biodiesel yield (reaction time between 4 h, amount of catalyst used was 5 wt.% of RBO, and RBO to ratio methanol 1:12)

3.2.2. Effect of RBO to methanol mole ratio

The transesterification is a reversible reaction. Moreover, it consists of three consecutive reversible reactions. As per Le Chatelier's principle, biodiesel yield can be enhanced by increasing the reactant concentration so that the reaction equilibrium shifts to the right side as the product forms. Methanol is widely used because its reaction with triglycerides runs faster and provides a higher conversion in a shorter time when compared to other alcohols. Furthermore, the long-chain alcohols are easily contaminated by water. The oil to methanol stoichiometric mole ratio was 1:3. Thus, in order to shift the reaction equilibrium to the right side the methanol to oil stoichiometric mole ratio ought to be larger than that of stoichiometric mole ratio. We applied the high methanol to oil mole ratio in order to increase the miscibility and to reduce the mass transfer limitation in the alcohol and oil phase. In this study, the RBO to methanol mole ratio was varied to 1:6, 1:8, 1:10 and 1:12, respectively. Figure 5 describes the effect of RBO to methanol mole ratio on the biodiesel yield. As shown in Figure 5, by using mole ratios of 1:6 and

1:8, biodiesel yields were 62.4% and 70.8% respectively. Then, by using the mole ratios of 1:8 and 1:10, the biodiesel yield was increased to 74.1% and 81.9% respectively at. The highest biodiesel yield was obtained at RBO to methanol by using a mole ratio of 1:12.

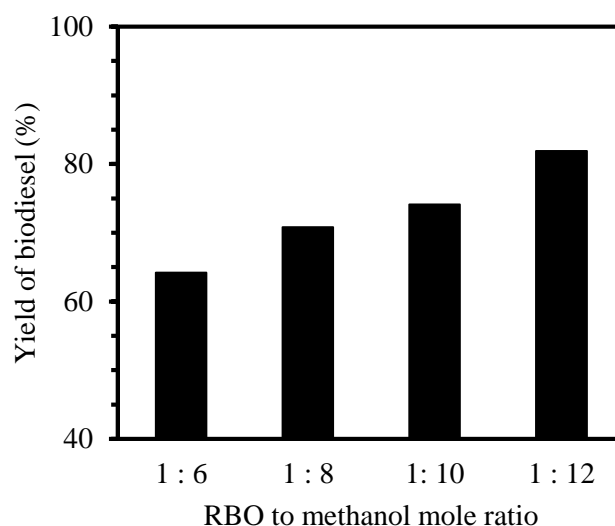

Figure 5 The effect of RBO to methanol mole ratio on the yield of biodiesel (reaction time between 4 h, amount of catalyst used was 55 wt.% of RBO, and reaction temperature was on 60°C)

3.2.3. Effect of the amount of catalyst

The amount of catalyst, required for biodiesel production, has a significant impact on the cost of production and the environment. The use of large amounts of catalysts in transesterification reaction increases the rate of reaction to achieve higher biodiesel yields. However, in order to reduce the cost of production, it is preferable to apply the minimum amount of catalyst and use the minimum amount of chemicals. It is observed from Figure 6 that, when the amount of the catalyst increases from 0.5 to 5 wt.% of RBO increased the biodiesel yield. The highest biodiesel yield was 81.9% which was obtained when the catalyst amount was 5 wt.% of RBO. The increases to the amounts of the catalysts enhances the availability and number of catalytically active sites and, in turn, increases the biodiesel yield.

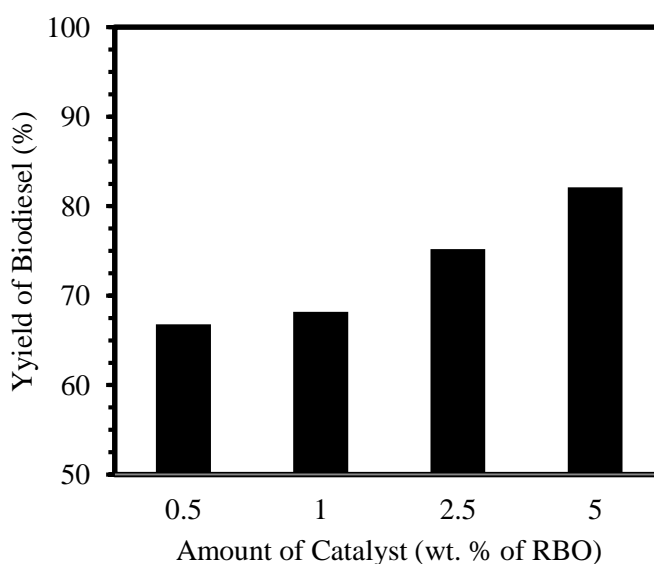

Figure 6 The effect of amount of catalyst on the yield of biodiesel (reaction time 4 h, RBO to methanol ratio 1:12, and reaction temperature was on 60°C)

3.2.4. Catalyst reusability

The reusability of catalyst is an important factor in the sustainability of using heterogeneous catalysts for biodiesel production. Prior to reuse, the K/NZ catalysts were regenerated by washing them in n hexane to remove the remaining impurities on the catalyst's surface and internal pore. The transesterification reaction was carried out under constant operating conditions (reaction time 4 hours, RBO to methanol ratio 1:12, and reaction temperature was on 60°C). As shown in Figure 7, the biodiesel yield was found to be 81.9% (first use), 62.7% (second use) and 52.3% (third use). The reduction of biodiesel yield could be because of the leaching of active sites on the catalysts' surfaces. Leaching of the active phase to the alcoholic phase can be attributed to the bond breaking and formation of K^+ and CHO^- (Baroutian et al., 2011).

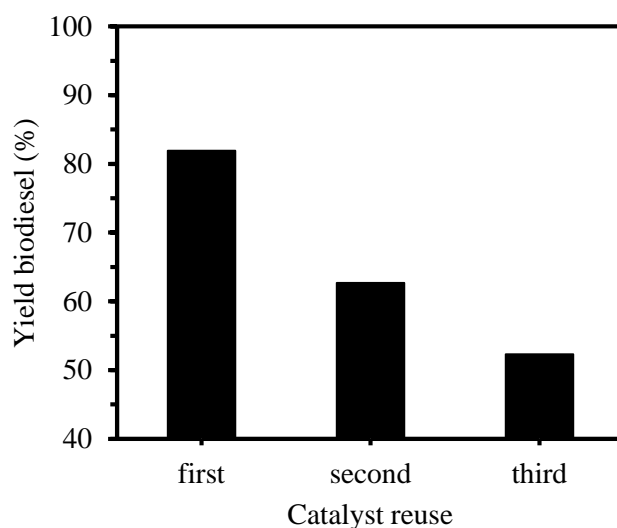

Figure 7 The reusability of the K/NZ catalyst (reaction time 4 h, RBO to methanol mole ratio 1:12, the amount of catalyst of 5 wt.% RBO, and reaction temperature was on 60°C)

3.3. Economic Analysis

We performed an economic analysis by using the NPV method for the biodiesel production project. The basis of the project's capital investment is determined on the manufacturing cost and the working capital. The manufacturing cost comes mainly from the cost of raw materials (RBO, methanol, catalyst, chemicals, etc.), labor and utilities (steam, water, electricity). As by-product, Glycerol has great value in some industries and, thus, it was considered that there was revenue to be obtained from the glycerol generated in the project. The length of the project is 10 years and the annual bank interest rate is 12.5% per year. Table 2 presents the results of the economic analysis.

Table 2 Economic analysis

Parameters	Value
Total biodiesel production (tons/year)	80,400
Lifetime of project (year)	10
Net Present Value (IDR)	372,326,000,000
Internal Rate of Return	16.66%
Break Even Point (BEP)	57.64%
Biodiesel cost (IDR/liter)	10,300

As shown in Table 2, the NPV and the IRR resulted in a profitable investment due to the project's NPV being greater than its capital cost and the IRR was 1.5 times higher than the bank interest

rate (6.5%). A project with a higher NPV is considered to be more interesting because it indicates that the project's projected generated earnings generated exceed the predicted costs. The NPV assists, also, in evaluating a project realistically. The greater the IRR, the greater the project is assessed to be potentially economic since the IRR refers to the return which can be earned on the capital invested in the project. The project's Break-Even Point (BEP) value was achieved at 57.64% with a capacity of 80,400 tons/year. The BEP is the point at which the product stops costing money to produce and sell and starts to generate a profit for the company. At the BEP, the production costs equal income from sales.

The cost of biodiesel is calculated by dividing total operating costs with the total cost of soybean oil productivity. The cost of biodiesel, produced from the RBO, was higher than that from petroleum diesel. The Indonesian Government's policies can influence greatly the competitiveness of biodiesel fuel relative to petroleum diesel strongly. In order to commercialize biodiesel, there is a need to pay subsidies since the biodiesel prices are comparatively higher than those of petroleum fuel. Furthermore, the Indonesian Government has to interfere in to the market through regulating and supporting the private sector companies in the form of infrastructure, tax and reduction of commodity prices. The farmer support programs were intensified, also, to promote the growth of biodiesel in the domestic market. The use of biodiesel was driven by increasing the annual road tax which drivers had to pay when using petroleum diesel due to the negative impact of diesel engines' emissions on the environment.

4. CONCLUSION

In order to study and optimize the reaction conditions, the transesterification reaction of RBO using K/NZ catalysts were conducted by varying many parameters such as reaction temperature, RBO to methanol mole ratio, and catalyst amount. The optimal conditions were reaction temperature of 67.5°C, RBO to methanol mole ratio of 1:12, and catalyst amount of wt.5%. RBO. Under the obtained optimum conditions, the biodiesel yield was 83.2%. This indicated that potassium supported on natural zeolite (the K/NZ catalyst) could be used as a catalyst for the transesterification of RBO. The K/NZ catalyst could be reused up to 3 times for esterification reactions; however, this reduced the biodiesel yield to 52.3%.

5. ACKNOWLEDGEMENT

The authors would like to thank the *Direktorat Jenderal Penguatan Riset dan Pengembangan, Direktorat Riset dan Pengabdian Masyarakat, Kemenristekdikti*, Indonesia for financial support through the *Penelitian Strategis Nasional Institusi 2017* research grant.

6. REFERENCES

- Al-Jammal, N., Al-Hamamre, Z., Alnaief, M., 2016. Manufacturing of Zeolite Based Catalyst from Zeolite Tuft for Biodiesel Production from Waste Sunflower Oil. *Renewable Energy*, Volume 93, pp. 449–459
- Alonso, D.M., Mariscal, R., Moreno-Tost, R., Poves, M.D.Z., Granados M.L., 2007. Potassium Leaching during Triglyceride Transesterification using K/ γ -Al₂O₃ Catalysts. *Catalysis Communications*, Volume 8(12), pp. 2074–2080
- Augustia, V.A.S., Djalal, R.A., Sutrisno, B., Hidayat, A., 2018. Kinetic Study of Free Fatty Acid in Palm Fatty Acid Distillate (PFAD) over Sugarcane Bagasse Catalyst. *IOP Conference Series: Earth and Environmental Science*, Volume 105(1), pp. 012065
- Baroutian, S., Aroua, M.K., Raman, A.A.A., Sulaiman, N.M.N., 2011. A Packed Bed Membrane Reactor for Production of Biodiesel using Activated Carbon Supported Catalyst. *Bioresource Technology*, Volume 102(2), pp. 1095–1102

- Chen, W.K., Tseng, H.H., Wei, M.C., Su, E.C., Chiu, I.C., 2014. Transesterification of Canola Oil as Biodiesel over Na/Zr-SBA-15 Catalysts: Effect of Zirconium Content. *International Journal of Hydrogen Energy*, Volume 39(34), pp. 19555–19562
- Chen, Y.H., Huang, Y.H., Lin, R.H., Shang, N.C., Chang, C.Y., Chang, C.C., Chiang, P.C., Hu, C.Y., 2011. Biodiesel Production in a Rotating Packed Bed using K/ γ -Al₂O₃ Solid Catalyst. *Journal of the Taiwan Institute of Chemical Engineers*, Volume 42(6), pp. 937–944
- Dai, Y.M., Wu, J.S., Chen, C.C., Chen, K.T., 2015. Evaluating the Optimum Operating Parameters on Transesterification Reaction for Biodiesel Production over a LiAlO₂ Catalyst. *Chemical Engineering Journal*, Volume 280, pp. 370–376
- de Lima, A.L., Mbengue, A., Gil, R.A.S.S., Ronconi, C.M., Mota, C.J.A., 2014. Synthesis of Amine-functionalized Mesoporous Silica Basic Catalysts for Biodiesel Production. *Catalysis Today*, Volume 226, pp. 210–216
- Hidayat, A. Rochmadi, Wijaya, K., Budiman, A., 2015. Reaction Kinetics of Free Fatty Acids Esterification in Palm Fatty Acid Distillate using Coconut Shell Biochar Sulfonated Catalyst. *AIP Conference Proceedings*, Volume 1699, pp. 050005
- Hidayat, A., Rochmadi, Wijaya, K., Budiman, A., 2016. Removal of Free Fatty Acid in Palm Fatty Acid Distillate using Sulfonated Carbon Catalyst Derived from Biomass Waste for Biodiesel Production. *IOP Conference Series: Materials Science and Engineering*, Volume 105(1), pp. 012026
- Hidayat, A., Sutrisno, B., 2017. Esterification Free Fatty Acid in Sludge Palm Oil using ZrO₂/SO₄²⁻ - Rice Husk Ash Catalyst. *AIP Conference Proceedings*, Volume 1840, pp. 050001
- Jaya, N., Selvan, B.K., Vennison, S.J., 2015. Synthesis of Biodiesel from Pongamia Oil using Heterogeneous Ion-exchange Resin Catalyst. *Ecotoxicology and Environmental Safety*, Volume 121, pp. 3–9
- Kusuma, R.I., Hadinoto, J.P., Ayucitra, A., Soetaredjo, F.E., Ismadji S., 2013. Natural Zeolite from Pacitan Indonesia, as Catalyst Support for Transesterification of Palm Oil. *Applied Clay Science*, Volume 74, pp. 121–126
- Marchetti J.M., Errazu A.F., 2008. Technoeconomic Study of Supercritical Biodiesel Production Plant. *Energy Conversion and Management*, Volume 49(8), pp. 2160–2164
- Mardhiah H.H., Ong H.C., Masjuki H.H., Lim S., Lee H.V., 2017. A Review on Latest Developments and Future Prospects of Heterogeneous Catalyst in Biodiesel Production from Non-edible Oils. *Renewable and Sustainable Energy Reviews*, Volume 67, pp. 1225–1236
- Nasreen, S., Liu, H., Qureshi, L.A., Sissou, Z., Skala, D., 2016. Cerium–manganese Oxide as Catalyst for Transesterification of Soybean Oil with Subcritical Methanol. *Fuel Processing Technology*, Volume 148, pp. 76–84
- Nowicki, J., Lach, J., Organek, M., Sabura, E., 2016. Transesterification of Rapeseed Oil to Biodiesel over Zr-doped MgAl Hydrotalcites. *Applied Catalysis A: General*, Volume 524, pp. 17–24
- Pradana, Y.S., Hidayat, A.H., Prasetya, A., Budiman, A., 2017. Biodiesel Production in a Reactive Distillation Column Catalyzed by Heterogeneous Potassium Catalyst. *Energy Procedia*, Volume 143, pp.742–747
- Saba, T., Estephane, J., El Khoury, B., El Khoury, M., Khazma, M., El Zakhem, H., Aouad, S., 2016. Biodiesel Production from Refined Sunflower Vegetable Oil over KOH/ZSM₅ Catalysts. *Renewable Energy*, Volume 90, pp. 301–306
- Shah, M., Tariq, M., Ali, S., Guo, Q.X., Fu, Y., 2014. Transesterification of Jojoba Oil, Sunflower Oil, Neem Oil, Rocket Seed Oil and Linseed Oil by Tin Catalysts. *Biomass and Bioenergy*, Volume 70, pp. 225–229

- Sudsakorn, K., Saiwuttikul, S., Palitsakun, S., Seubsai, A., Limtrakul, J., 2017. Biodiesel Production from *Jatropha Curcas* Oil using Strontium-doped CaO/MgO Catalyst. *Journal of Environmental Chemical Engineering*, Volume 5(3), pp. 2845–2852
- Takagaki, A., Toda, M., Okamura, M., Kondo, J.N., Hayashi, S., Domen, K., Hara, M., 2006. Esterification of Higher Fatty Acids by a Novel Strong Solid Acid. *Catalysis Today*, Volume 116(2), pp. 157–161
- Taufiq-Yap, Y.H., Teo, S.H., Rashid, U., Islam, A., Hussien, M.Z., Lee K.T., 2014. Transesterification of *Jatropha curcas* Crude Oil to Biodiesel on Calcium Lanthanum Mixed Oxide Catalyst: Effect of Stoichiometric Composition. *Energy Conversion and Management*, Volume 88, pp.1290–1296
- West, A.H., Posarac, D., Ellis, N. 2008. Assessment of Four Biodiesel Production Processes using HYSYS Plant. *Bioresource Technology*, Volume 99(14), pp. 6587–6601
- Wu, H., Zhang, J., Wei, Q., Zheng, J., Zhang, J. 2013. Transesterification of Soybean Oil to Biodiesel using Zeolite Supported CaO as Strong Base Catalysts. *Fuel Processing Technology*, Volume 109, pp. 13–18
- Xie, W., Fan, M., 2014. Biodiesel Production by Transesterification using Tetraalkylammonium Hydroxides Immobilized onto SBA-15 as a Solid Catalyst. *Chemical Engineering Journal*, Volume 239, pp. 60–67
- You, Y.D., Shie, J.L., Chang, C.Y., Huang, S.H., Pai, C.Y., Yu, Y.H., Chang, C.H., 2008. Economic Cost Analysis of Biodiesel Production: Case in Soybean Oil. *Energy Fuels*, Volume 22(1), pp. 182–189
- Yusuff, A.S., Adeniyi, O.D., Olutoye, M.A., Akpan, U.G., 2018. Development and Characterization of a Composite Anthill-chicken Eggshell Catalyst for Biodiesel Production from Waste Frying Oil. *International Journal of Technology*, Volume 9(1), pp. 110–119
- Zhang, Y., Dube, M.A., McLean, D.D., Kates, M., 2003. Biodiesel Production from Waste Cooking Oil: 2 Economic Assessment and Sensitivity Analysis. *Bioresource Technology*, Volume 90(3), pp. 229–240

Biodiesel Production from Rice Bran Oil over Modified Natural Zeolite Catalyst

Authors

Authors and Affiliations

Arif Hidayat, Nur Indah Fajar Mukti, Bagus Handoko, Bachrun Sutrisno

Corresponding email: ✉ arif.hidayat@uii.ac.id (mailto:arif.hidayat@uii.ac.id)

Published at : 27 Apr 2018

Volume : IJtech (https://ijtech.eng.ui.ac.id/) Vol 9, No 2 (2018) (https://ijtech.eng.ui.ac.id/issue/41)

DOI : https://doi.org/10.14716/ijtech.v9i2.1084 (https://doi.org/10.14716/ijtech.v9i2.1084)

Cite this article as:

Hidayat, A., Mukti, N.I.F., Handoko, B., Sutrisno, B., 2018. Biodiesel Production from Rice Bran Oil over Modified Natural Zeolite Catalyst. *International Journal of Technology*. Volume 9(2), pp. 400-411

[Export to BibTeX and RIS](#)

1,256

Downloads

Abstract

The purpose of this study is to develop natural zeolite impregnated with potassium nitrate (KNO_3) as a heterogenous catalyst for the transesterification of rice bran oil (RBO) in order to produce Fatty Acid Methyl Ester (FAME). We conducted the Nitrogen adsorption-desorption method, Fourier Transform Infra-Red (FT-IR) spectrometer, and X-Ray Diffraction (XRD) analysis in order to characterize the physicochemical properties of the modified natural zeolite catalysts. We investigated the influences of RBO to methanol mole ratio in the range of 1:6 to 1:12. The variation of natural zeolite catalyst amount performed, also, at 1, 2.5, 5 and 10 wt. % of RBO. Moreover, the reaction temperatures were varied at room temperature (32°C), 60°C and 67.5°C . The highest biodiesel yield was 83.2% which was obtained at a ratio of 1:12 RBO to methanol mole, an amount of modified natural zeolite catalyst of 10 wt.% of RBO and a reaction temperature of 67.5°C . In order to study the reusability of modified natural zeolite catalyst, three successive transesterification reactions were carried out using the same reaction conditions.

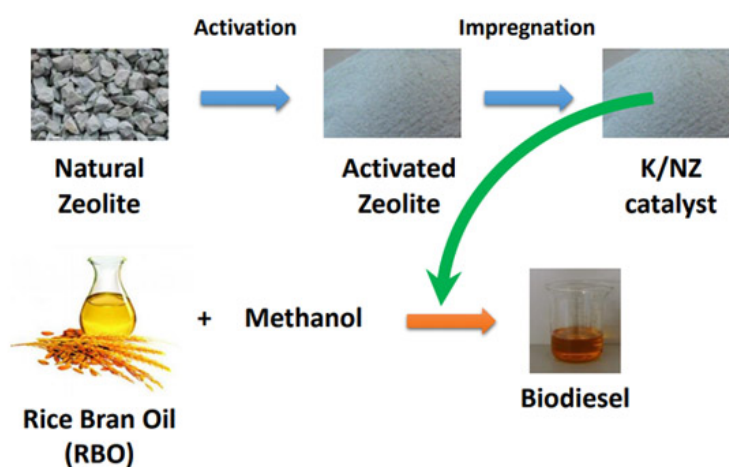

Keywords

Biodiesel; Catalyst; Natural zeolite; Potassium; Rice bran oil (RBO)

Conclusion

In order to study and optimize the reaction conditions, the transesterification reaction of RBO using K/NZ catalysts were conducted by varying many parameters such as reaction temperature, RBO to methanol mole ratio, and catalyst amount. The optimal conditions were reaction temperature of 67.5°C , RBO to methanol mole ratio of 1:12, and catalyst amount of wt.5%. RBO. Under the obtained optimum conditions, the biodiesel yield was 83.2%. This indicated that potassium supported on natural zeolite (the K/NZ catalyst) could be used as a catalyst for the transesterification of RBO. The K/NZ catalyst could be reused up to 3 times for esterification reactions; however, this reduced the biodiesel yield to 52.3%.

Acknowledgement

The authors would like to thank the *Direktorat Jenderal Penguatan Riset dan Pengembangan, Direktorat Riset dan Pengabdian Masyarakat, Kemenristekdikti, Indonesia* for financial support through the *Penelitian Strategis Nasional Institusi 2017* research grant.

References

- Al-Jammal, N., Al-Hamamre, Z., Alnaief, M., 2016. Manufacturing of Zeolite Based Catalyst from Zeolite Tuft for Biodiesel Production from Waste Sunflower Oil. *Renewable Energy*, Volume 93, pp. 449–459
- Alonso, D.M., Mariscal, R., Moreno-Tost, R., Poves, M.D.Z., Granados M.L., 2007. Potassium Leaching during Triglyceride Transesterification using K/g-Al₂O₃ Catalysts. *Catalysis Communications*, Volume 8(12), pp. 2074–2080
- Augustia, V.A.S., Djalal, R.A., Sutrisno, B., Hidayat, A., 2018. Kinetic Study of Free Fatty Acid in Palm Fatty Acid Distillate (PFAD) over Sugarcane Bagasse Catalyst. *IOP Conference Series: Earth and Environmental Science*, Volume 105(1), pp. 012065
- Baroutian, S., Aroua, M.K., Raman, A.A.A., Sulaiman, N.M.N., 2011. A Packed Bed Membrane Reactor for Production of Biodiesel using Activated Carbon Supported Catalyst. *Bioresource Technology*, Volume 102(2), pp. 1095–1102
- Chen, W.K., Tseng, H.H., Wei, M.C., Su, E.C., Chiu, I.C., 2014. Transesterification of Canola Oil as Biodiesel over Na/Zr-SBA-15 Catalysts: Effect of Zirconium Content. *International Journal of Hydrogen Energy*, Volume 39(34), pp. 19555–19562
- Chen, Y.H., Huang, Y.H., Lin, R.H., Shang, N.C., Chang, C.Y., Chang, C.C., Chiang, P.C., Hu, C.Y., 2011. Biodiesel Production in a Rotating Packed Bed using K⁺-Al₂O₃ Solid Catalyst. *Journal of the Taiwan Institute of Chemical Engineers*, Volume 42(6), pp. 937–944
- Dai, Y.M., Wu, J.S., Chen, C.C., Chen, K.T., 2015. Evaluating the Optimum Operating Parameters on Transesterification Reaction for Biodiesel Production over a LiAlO₂ Catalyst. *Chemical Engineering Journal*, Volume 280, pp. 370–376
- de Lima, A.L., Mbengue, A., Gil, R.A.S.S., Ronconi, C.M., Mota, C.J.A., 2014. Synthesis of Amine-functionalized Mesoporous Silica Basic Catalysts for Biodiesel Production. *Catalysis Today*, Volume 226, pp. 210–216
- Hidayat, A. Rochmadi, Wijaya, K., Budiman, A., 2015. Reaction Kinetics of Free Fatty Acids Esterification in Palm Fatty Acid Distillate using Coconut Shell Biochar Sulfonated Catalyst. *AIP Conference Proceedings*, Volume 1699, pp. 050005
- Hidayat, A., Rochmadi, Wijaya, K., Budiman, A., 2016. Removal of Free Fatty Acid in Palm Fatty Acid Distillate using Sulfonated Carbon Catalyst Derived from Biomass Waste for Biodiesel Production. *IOP Conference Series: Materials Science and Engineering*, Volume 105(1), pp. 012026
- Hidayat, A., Sutrisno, B., 2017. Esterification Free Fatty Acid in Sludge Palm Oil using ZrO₂/SO₄²⁻ - Rice Husk Ash Catalyst. *AIP Conference Proceedings*, Volume 1840, pp. 050001
- Jaya, N., Selvan, B.K., Vennison, S.J., 2015. Synthesis of Biodiesel from Pongamia Oil using Heterogeneous Ion-exchange Resin Catalyst. *Ecotoxicology and Environmental Safety*, Volume 121, pp. 3–9
- Kusuma, R.I., Hadinoto, J.P., Ayucitra, A., Soetaredjo, F.E., Ismadji S., 2013. Natural Zeolite from Pacitan Indonesia, as Catalyst Support for Transesterification of Palm Oil. *Applied Clay Science*, Volume 74, pp. 121–126
- Marchetti J.M., Errazu A.F., 2008. Technoeconomic Study of Supercritical Biodiesel Production Plant. *Energy Conversion and Management*, Volume 49(8), pp. 2160–2164
- Mardhiah H.H., Ong H.C., Masjuki H.H., Lim S., Lee H.V., 2017. A Review on Latest Developments and Future Prospects of Heterogeneous Catalyst in Biodiesel Production from Non-edible Oils. *Renewable and Sustainable Energy Reviews*, Volume 67, pp. 1225–1236
- Nasreen, S., Liu, H., Qureshi, L.A., Sissou, Z., Skala, D., 2016. Cerium–manganese Oxide as Catalyst for Transesterification of Soybean Oil with Subcritical Methanol. *Fuel Processing Technology*, Volume 148, pp. 76–84
- Nowicki, J., Lach, J., Organek, M., Sabura, E., 2016. Transesterification of Rapeseed Oil to Biodiesel over Zr-doped MgAl Hydrotalcites. *Applied Catalysis A: General*, Volume 524, pp. 17–24
- Pradana, Y.S., Hidayat, A.H., Prasetya, A., Budiman, A., 2017. Biodiesel Production in a Reactive Distillation Column Catalyzed by Heterogeneous Potassium Catalyst. *Energy Procedia*, Volume 143, pp.742–747
- Saba, T., Estephane, J., El Khoury, B., El Khoury, M., Khazma, M., El Zakhem, H., Aouad, S., 2016. Biodiesel Production from Refined Sunflower Vegetable Oil over KOH/ZSM₅ Catalysts. *Renewable Energy*, Volume 90, pp. 301–306
- Shah, M., Tariq, M., Ali, S., Guo, Q.X., Fu, Y., 2014. Transesterification of Jojoba Oil, Sunflower Oil, Neem Oil, Rocket Seed Oil and Linseed Oil by Tin Catalysts. *Biomass and Bioenergy*, Volume 70, pp. 225–229
- Sudsakorn, K., Saiwuttikul, S., Palisakun, S., Seubsai, A., Limtrakul, J., 2017. Biodiesel Production from Jatropha Curcas Oil using Strontium-doped CaO/MgO Catalyst. *Journal of Environmental Chemical Engineering*, Volume 5(3), pp. 2845–2852
- Takagaki, A., Toda, M., Okamura, M., Kondo, J.N., Hayashi, S., Domen, K., Hara, M., 2006. Esterification of Higher Fatty Acids by a Novel Strong Solid Acid. *Catalysis Today*, Volume 116(2), pp. 157–161
- Taufiq-Yap, Y.H., Teo, S.H., Rashid, U., Islam, A., Hussien, M.Z., Lee K.T., 2014. Transesterification of *Jatropha curcas* Crude Oil to Biodiesel on Calcium Lanthanum Mixed Oxide Catalyst: Effect of Stoichiometric Composition. *Energy Conversion and Management*, Volume 88, pp.1290–1296
- West, A.H., Posarac, D., Ellis, N. 2008. Assessment of Four Biodiesel Production Processes using HYSYS Plant. *Bioresource Technology*, Volume 99(14), pp. 6587–6601
- Wu, H., Zhang, J., Wei, Q., Zheng, J., Zhang, J. 2013. Transesterification of Soybean Oil to Biodiesel using Zeolite Supported CaO as Strong Base Catalysts. *Fuel Processing Technology*, Volume 109, pp. 13–18
- Xie, W., Fan, M., 2014. Biodiesel Production by Transesterification using Tetraalkylammonium Hydroxides Immobilized onto SBA-15 as a Solid Catalyst. *Chemical Engineering Journal*, Volume 239, pp. 60–67
- You, Y.D., Shie, J.L., Chang, C.Y., Huang, S.H., Pai, C.Y., Yu, Y.H., Chang, C.H., 2008. Economic Cost Analysis of Biodiesel Production: Case in Soybean Oil. *Energy Fuels*, Volume 22(1), pp. 182–189
- Yusuff, A.S., Adeniyi, O.D., Olutoye, M.A., Akpan, U.G., 2018. Development and Characterization of a Composite Anthill-chicken Eggshell Catalyst for Biodiesel Production from Waste Frying Oil. *International Journal of Technology*, Volume 9(1), pp. 110–119
- Zhang, Y., Dube, M.A., McLean, D.D., Kates, M., 2003. Biodiesel Production from Waste Cooking Oil: 2 Economic Assessment and Sensitivity Analysis. *Bioresource Technology*, Volume 90(3), pp. 229–240

DOWNLOAD PDF  ([HTTPS://IJTECH.ENG.UI.AC.ID/DOWNLOAD/ARTICLE/1084](https://ijtech.eng.ui.ac.id/download/article/1084))

WHO CITE THIS PAPER  ([HTTPS://SCHOLAR.GOOGLE.COM/SCHOLAR?Q=BIODIESEL+PRODUCTION+FROM+RICE+BRAN+OIL+OVER+MODIFIED+NATURAL+ZEOLITE+CATALYST](https://scholar.google.com/scholar?q=biodiesel+production+from+rice+bran+oil+over+modified+natural+zeolite+catalyst))

SHARE ARTICLE 

Table of Contents

➤ Article

➤ Abstract

➤ Conclusion

➤ Acknowledgement

➤ References

Copyright © 2017 Faculty of Engineering
International Journal of Technology

IJTech secretariat, Engineering Center Bld., 2nd Fl.
Faculty of Engineering, Universitas Indonesia
Depok 16424, Indonesia.

EDITORIAL TEAM

Editor in Chief

1. Prof. Dr. Mohammed Ali Berawi, Universitas Indonesia, Indonesia

Managing Editor

1. Dr. Eny Kusriani, Universitas Indonesia, Indonesia

Members

1. Prof. Dr. Akhmad Herman Yuwono , Universitas Indonesia, Indonesia
2. Prof. Dr. Anwar Usman, Universiti Brunei Darussalam, Brunei Darussalam
3. Prof. Dr. Bambang Sugiarto, Universitas Indonesia, Indonesia
4. Dr. Cecilia Vale, University of Porto, Portugal
5. Prof. Dr. Dedi Priadi, Universitas Indonesia, Indonesia
6. Dr. Eko Adhi Setiawan, Universitas Indonesia, Indonesia
7. Prof. Dr. Esah Hamzah, Universiti Teknologi Malaysia, Malaysia
8. Dr. Giuseppe Lo Papa, Teagasc Rural Economy Research Centre, Ireland
9. Prof. Dr. Hamzah Abdul Rahman, Universiti Malaya, Malaysia
10. Dr. Hendri Dwi Saptioratri, Universitas Indonesia, Indonesia
11. Prof. Dr. Heri Hermansyah, S.T., M.Eng., IPU, Universitas Indonesia, Indonesia
12. Dr. Hng Huey Hoon, Nanyang Technological University, Singapore , Singapore
13. Dr. Imam Jauhari Maknun, Universitas Indonesia, Indonesia, Indonesia
14. Prof. Dr. Isti Surjandari, Universitas Indonesia, Indonesia
15. Dr. Johannes Widodo, National University of Singapore, Singapore
16. Prof. Dr. Jong-Taek Oh, Chonnam National University, Korea, Republic of
17. Dr. Lee Wilson, University of Saskatchewan, Canada
18. Dr. Muhamad Asvial, Universitas Indonesia, Indonesia
19. Dr. Muhamad Sahlan, Universitas Indonesia, Indonesia
20. Dr. Muhammad Arif Budiyanto, Universitas Indonesia, Indonesia
21. Prof. Dr. Muhammad Idris Saleh, Universiti Sains Malaysia, Malaysia
22. Dr. Muhammad Suryanegara, Universitas Indonesia, Indonesia
23. Prof. Dr. Nandy Putra, Universitas Indonesia, Indonesia
24. Dr. Nofrijon Sofyan, Universitas Indonesia, Indonesia
25. Dr. Nyoman Suwartha, Universitas Indonesia, Indonesia
26. Prof. Paramita Atmodiwiryo, Universitas Indonesia, Indonesia
27. Prof. Dr. Prof. Dr. Hideaki Ohgaki, Kyoto University, Japan
28. Prof. Dr. Raimundo Delgado, University of Porto, Portugal
29. Dr. Reza Kia, Sharif University of Technology, Iran (Islamic Republic of)
30. Dr. Roy Woodhead, Sheffield Hallam University, United Kingdom
31. Prof. Rui Calcada, University of Porto, Portugal
32. Dr. Ruki Harwahyu, Universitas Indonesia, Indonesia
33. Dr. Sam P. Sinha, Scientific Research & Development, United States
34. Prof. Dr. Simon P. Ringer, University of Sydney, Australia
35. Prof. Sri Harjanto, Universitas Indonesia, Indonesia
36. Prof. Dr. Sutrasno Kartohardjono, Universitas Indonesia, Indonesia
37. Prof. Dr. T. Yuri M. Zagloel, Universitas Indonesia, Indonesia
38. Prof. Dr. Toshio Shudo, Tokyo Metropolitan University, Japan

39. Prof. Dr. Yandi Andri Yatmo, Universitas Indonesia, Indonesia

40. Dr. Yudan Whulanza, Universitas Indonesia, Indonesia

41. Prof. Dr. Yung- Hui Lee, National Taiwan University, Taiwan

42. Dr. Yung-Jung Hsu, National Chiao Tung University, Taiwan

About the Journal

- Editorial Board (<https://ijtech.eng.ui.ac.id/people>)
- Focus and Scope (<https://ijtech.eng.ui.ac.id/about/5/focus-and-scope>)
- Online Submissions (<https://ijtech.eng.ui.ac.id/about/3/online-submission>)
- Publication Policy (<https://ijtech.eng.ui.ac.id/about/11/publication-policy>)
- Publication Ethics and Policy (<https://ijtech.eng.ui.ac.id/about/10/policy>)
- Author Guidelines (<https://ijtech.eng.ui.ac.id/about/4/author-guidelines>)
- List of Reviewers (<https://ijtech.eng.ui.ac.id/about/12>)

-
- Most downloaded papers (<https://ijtech.eng.ui.ac.id/home/mostdownloadedpapers>)
 - Most cited papers (<https://ijtech.eng.ui.ac.id/about/14>)

Login

Username

Password

Not as user?

Register (<https://ijtech.eng.ui.ac.id/register>)

LOGIN

IJTech

p-ISSN : 2086-9614 (<https://portal.issn.org/resource/ISSN/2086-9614>)

e-ISSN : 2087-2100 (<https://portal.issn.org/resource/ISSN/2087-2100>)

Journal Metrics



([https://www.scimagojr.com/journalsearch.php?](https://www.scimagojr.com/journalsearch.php?q=21100235612&tip=sid&exact=no)

[q=21100235612&tip=sid&exact=no](https://www.scimagojr.com/journalsearch.php?q=21100235612&tip=sid&exact=no))

Metrics by SCOPUS 2022

CiteScore 2021: **2.4**

CiteScoreTracker 2022: **2.0**

Source Normalized Impact per Paper (SNIP): **0.744**

Acceptance rate: **18.50 %**

Average time to publish: **133 days.**

📈 IJTech is indexed in



(<https://www.scopus.com/sourceid/21100235612>)



(<http://www.ebsco.com/index.asp>)



(<https://doaj.org/toc/2086-9614>)



([https://www.scimagojr.com/journalsearch.php?](https://www.scimagojr.com/journalsearch.php?q=21100235612&tip=sid)

[q=21100235612&tip=sid](https://www.scimagojr.com/journalsearch.php?q=21100235612&tip=sid))



([https://journals.indexcopernicus.com/search/details?](https://journals.indexcopernicus.com/search/details?id=31340)

[id=31340](https://journals.indexcopernicus.com/search/details?id=31340))



(<http://www.crossref.org>)



([https://scholar.google.co.id/scholar?](https://scholar.google.co.id/scholar?q=site%3Ahttp%3A%2F%2Fijtech.eng.ui.ac.id)

[q=site%3Ahttp%3A%2F%2Fijtech.eng.ui.ac.id](https://scholar.google.co.id/scholar?q=site%3Ahttp%3A%2F%2Fijtech.eng.ui.ac.id))



([https://mjl.clarivate.com/search-results?issn=2086-](https://mjl.clarivate.com/search-results?issn=2086-9614)

9614)

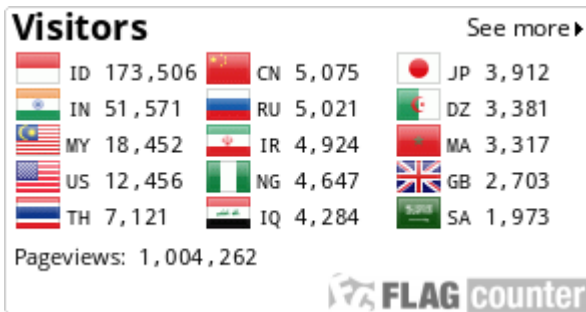

(<http://info.flagcounter.com/AoS7>)

Copyright © 2017 Faculty of Engineering
International Journal of Technology

IJTech secretariat, Engineering Center Bld., 2nd Fl.
Faculty of Engineering, Universitas Indonesia
Depok 16424, Indonesia.

JOURNAL ISSUE

International Journal of Technology

Volume 9 | Issue 2 (SE) | April 2018



www.ijtech.eng.ui.ac.id

Published by Faculty of Engineering, Universitas Indonesia

27 Apr 2018



Optimizing the Process Conditions in Science and Engineering for Improvement of Product Engineering (<https://ijtech.eng.ui.ac.id/article/view/1930>)

Eny Kusrini

Publication Date (Online):

Apr 27, 2018

DOI: <https://doi.org/10.14716/ijtech.v9i2.1930> (<https://doi.org/10.14716/ijtech.v9i2.1930>)

Pages : 212-218

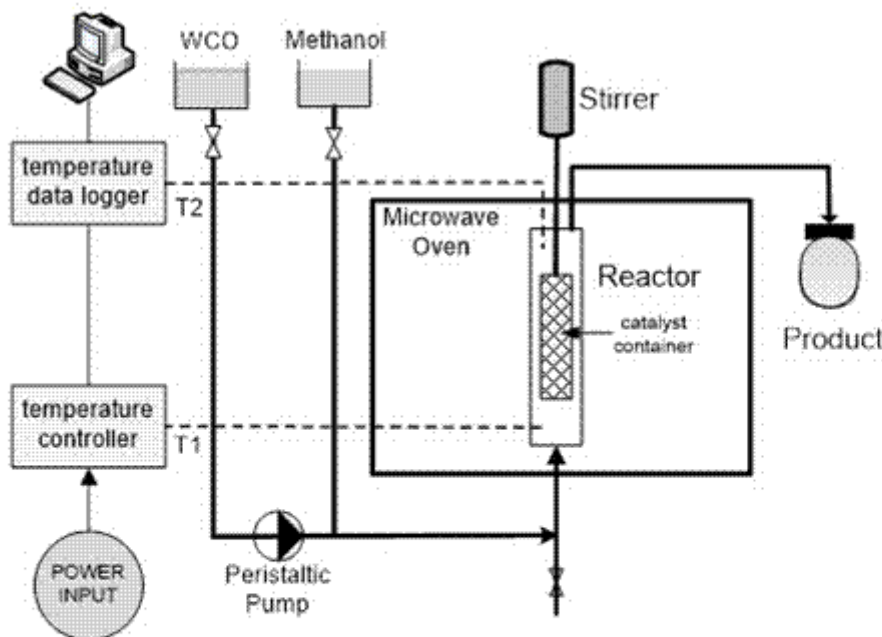

Optimization of Biodiesel Production using a Stirred Packed-bed Reactor (<https://ijtech.eng.ui.ac.id/article/view/1386>)

Farid Nasir Ani, Nur Hamzah Said, Mohd Farid Muhamad Said

Publication Date (Online):

Apr 27, 2018

DOI: <https://doi.org/10.14716/ijtech.v9i2.1386> (<https://doi.org/10.14716/ijtech.v9i2.1386>)

Pages : 219-228

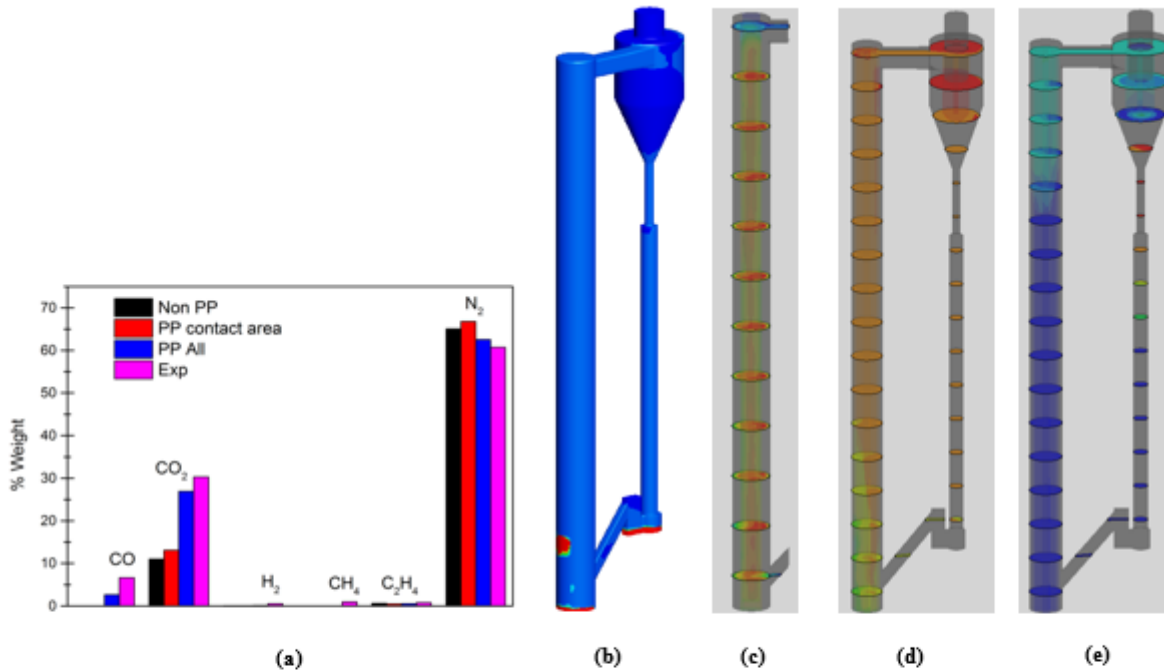

A 3D Eulerian multi-fluid approach has been developed to test the effect of the inclusion of particle-particle heat transfer models. The figures above show (a) capabilities of models in predicting the syngas composition, Spatial distributions of (b) inter-solid phase conduction, (c) axial gas phase velocity, (d) gas phase temperature, and (e) CO mass fraction for the model with the inclusions of both direct inter-solid phase heat transfer and through in-between fluid medium.

Numerical Study of Biomass Gasification in 3D Full-loop Circulating Fluidized Beds using a Eulerian Multi-fluid Model (<https://ijtech.eng.ui.ac.id/article/view/1212>)

Hadi Wahyudi, Mekro P. Pinem, Imron Rosyadi, Kevin Chu

Publication Date (Online):

Apr 27, 2018

DOI: <https://doi.org/10.14716/ijtech.v9i2.1212> (<https://doi.org/10.14716/ijtech.v9i2.1212>)

Pages : 229-237

EMISSION AND PERFORMANCE CHARACTERISTIC OF WASTE COOKING OIL BIODIESEL BLENDS IN A SINGLE DI DIESEL ENGINE

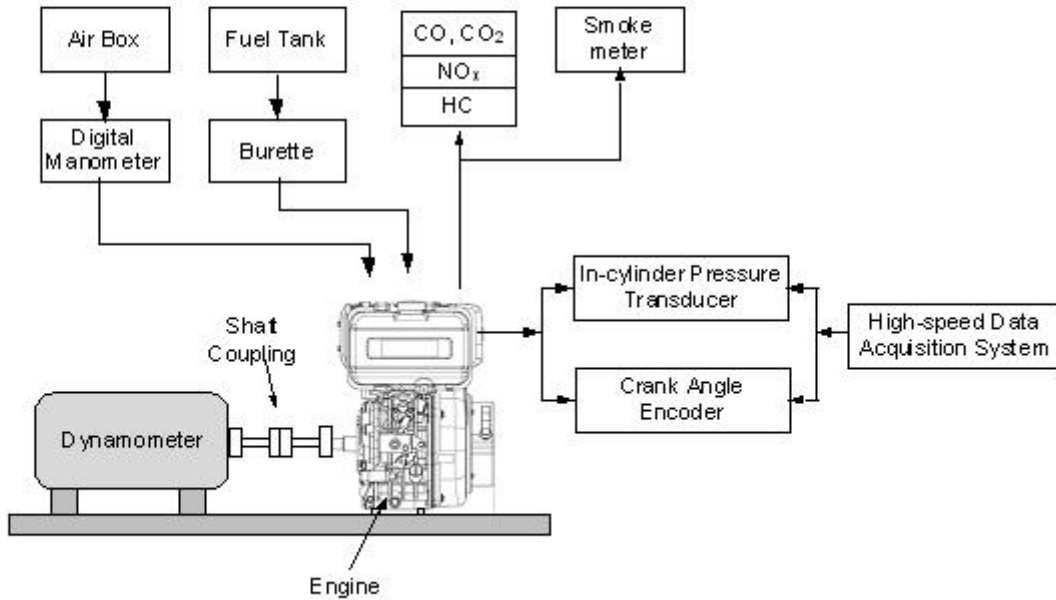

Emission and Performance Characteristics of Waste Cooking Oil Biodiesel Blends in a Single Direct Injection Diesel Engine (<https://ijtech.eng.ui.ac.id/article/view/1204>)

Nur Hamzah Said, F.N. Ani, Mohd Farid Muhamad Said

Publication Date (Online):

Apr 27, 2018

DOI: <https://doi.org/10.14716/ijtech.v9i2.1204> (<https://doi.org/10.14716/ijtech.v9i2.1204>)

Pages : 238-245

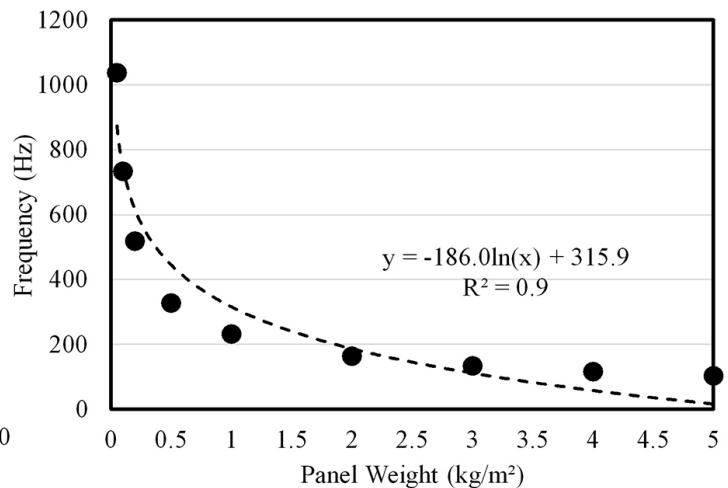
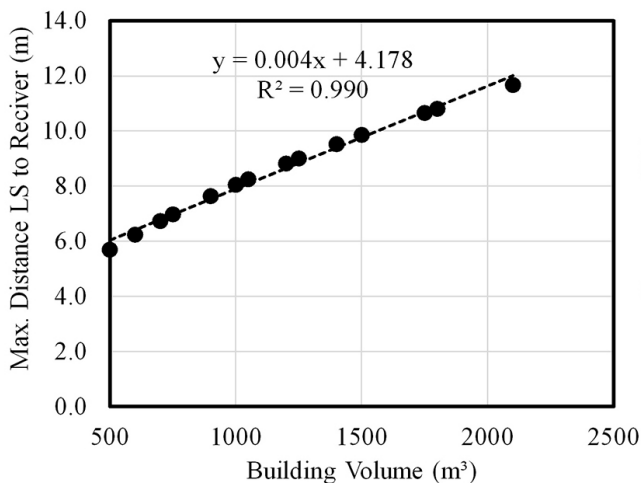

Optimization of Architectural Electroacoustics Design for the Interior Mezzanines of

Vertical Buildings (<https://ijtech.eng.ui.ac.id/article/view/1080>)

FX Teddy Badai Samodra

Publication Date (Online):

Apr 27, 2018

DOI: <https://doi.org/10.14716/ijtech.v9i2.1080> (<https://doi.org/10.14716/ijtech.v9i2.1080>)

Pages : 246-256

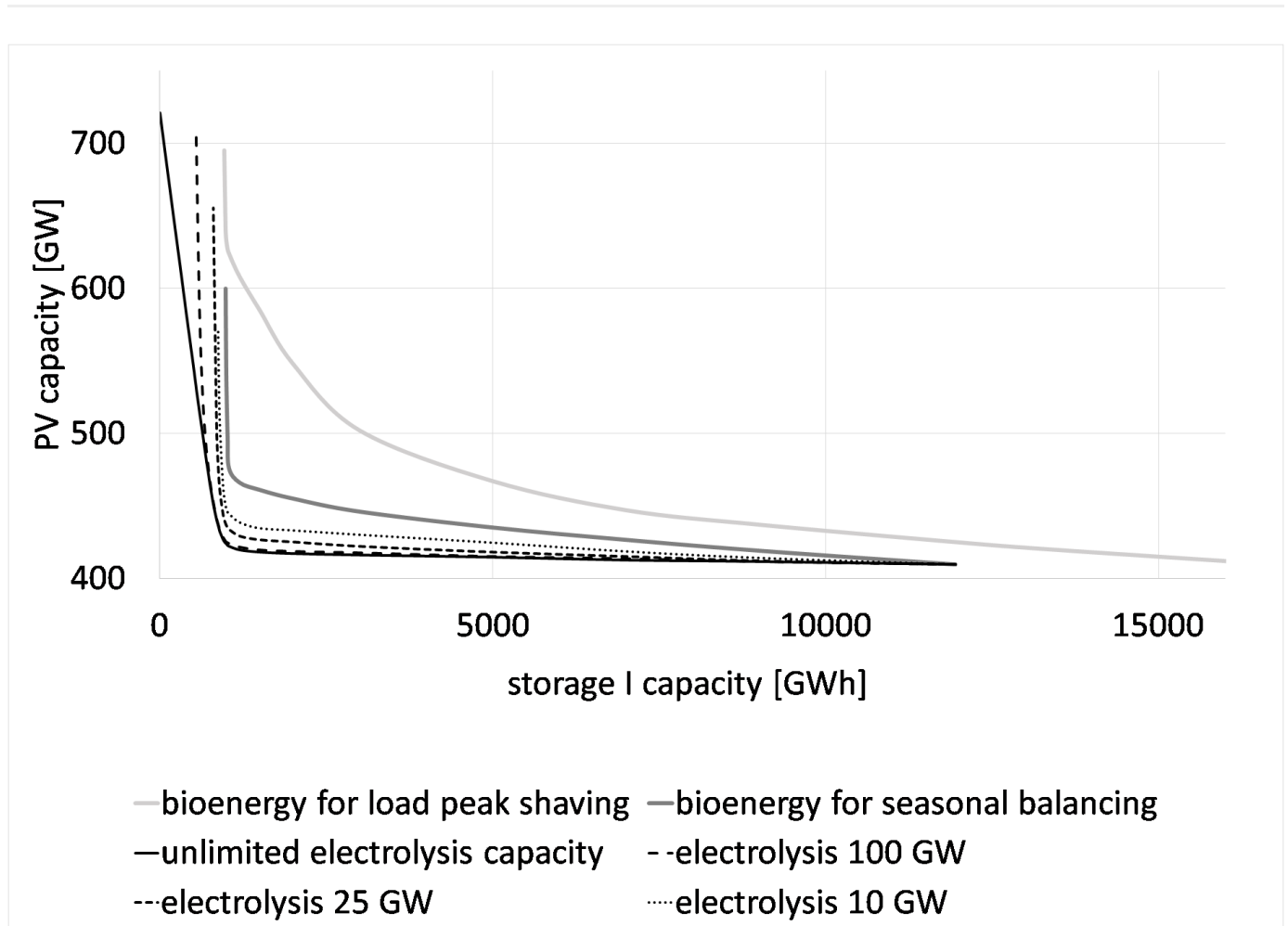

Challenges of a 100% Renewable Energy Supply in the Java-Bali Grid (<https://ijtech.eng.ui.ac.id/article/view/1027>)

Matthias Guenther

Publication Date (Online):

Apr 27, 2018

DOI: <https://doi.org/10.14716/ijtech.v9i2.1027> (<https://doi.org/10.14716/ijtech.v9i2.1027>)

Pages : 257-266

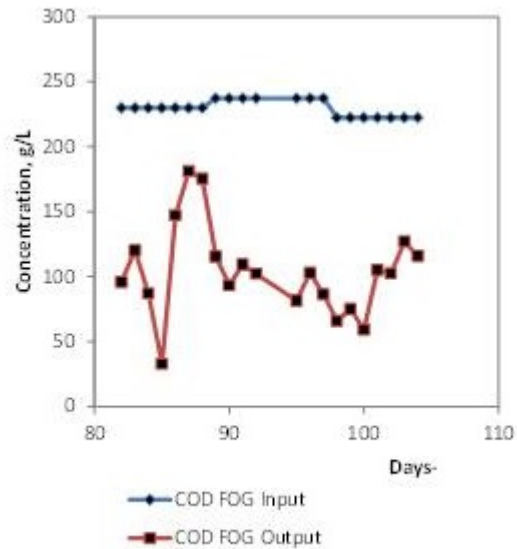
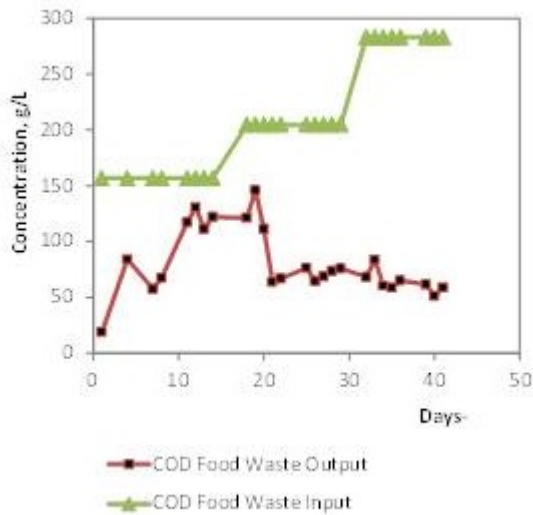
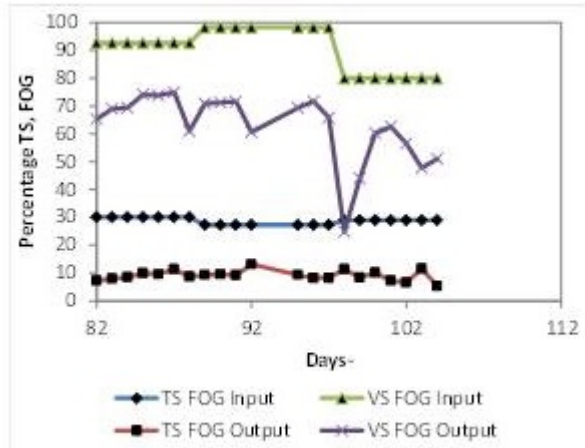
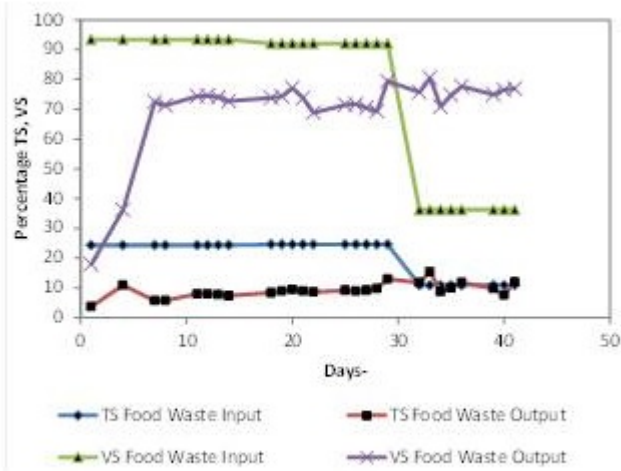

Effect of the Addition of Fat Oil and Grease (FOG) on the Performance of a Dry Anaerobic Digestion Food Waste Reactor (<https://ijtech.eng.ui.ac.id/article/view/1139>)

Dwita Fitriani Wijayanti, Nyoman Suwartha, Cindy Rianti Priadi

Publication Date (Online):

Apr 27, 2018

DOI: <https://doi.org/10.14716/ijtech.v9i2.1139> (<https://doi.org/10.14716/ijtech.v9i2.1139>)

Pages : 267-274

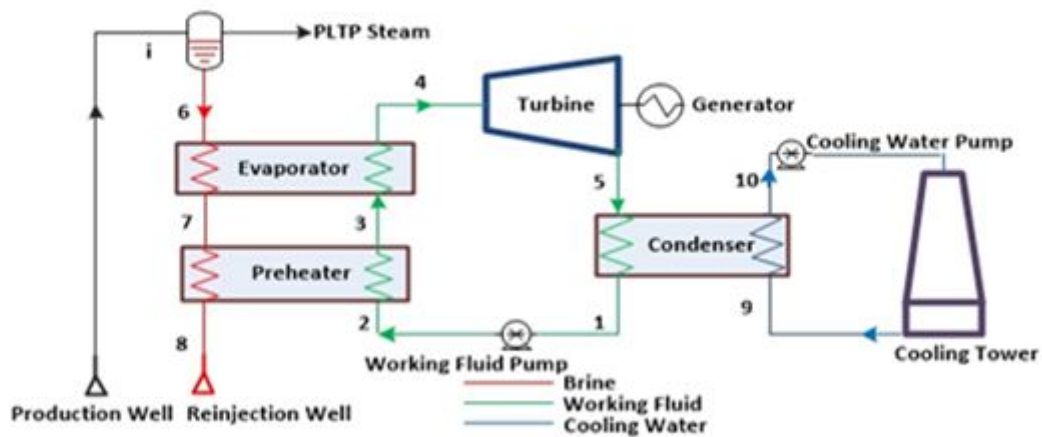

Figure 1 Schematic diagram of binary cycle system

Exergy Analysis and Exergoeconomic Optimization of a Binary Cycle System using a Multi Objective Genetic Algorithm (<https://ijtech.eng.ui.ac.id/article/view/1040>)

Nasruddin , Syaiful Nasution, Nyayu Aisyah, Arief Surachman, Agung Satrio Wibowo

Publication Date (Online):

Apr 27, 2018

DOI: <https://doi.org/10.14716/ijtech.v9i2.1040> (<https://doi.org/10.14716/ijtech.v9i2.1040>)

Pages : 275-286

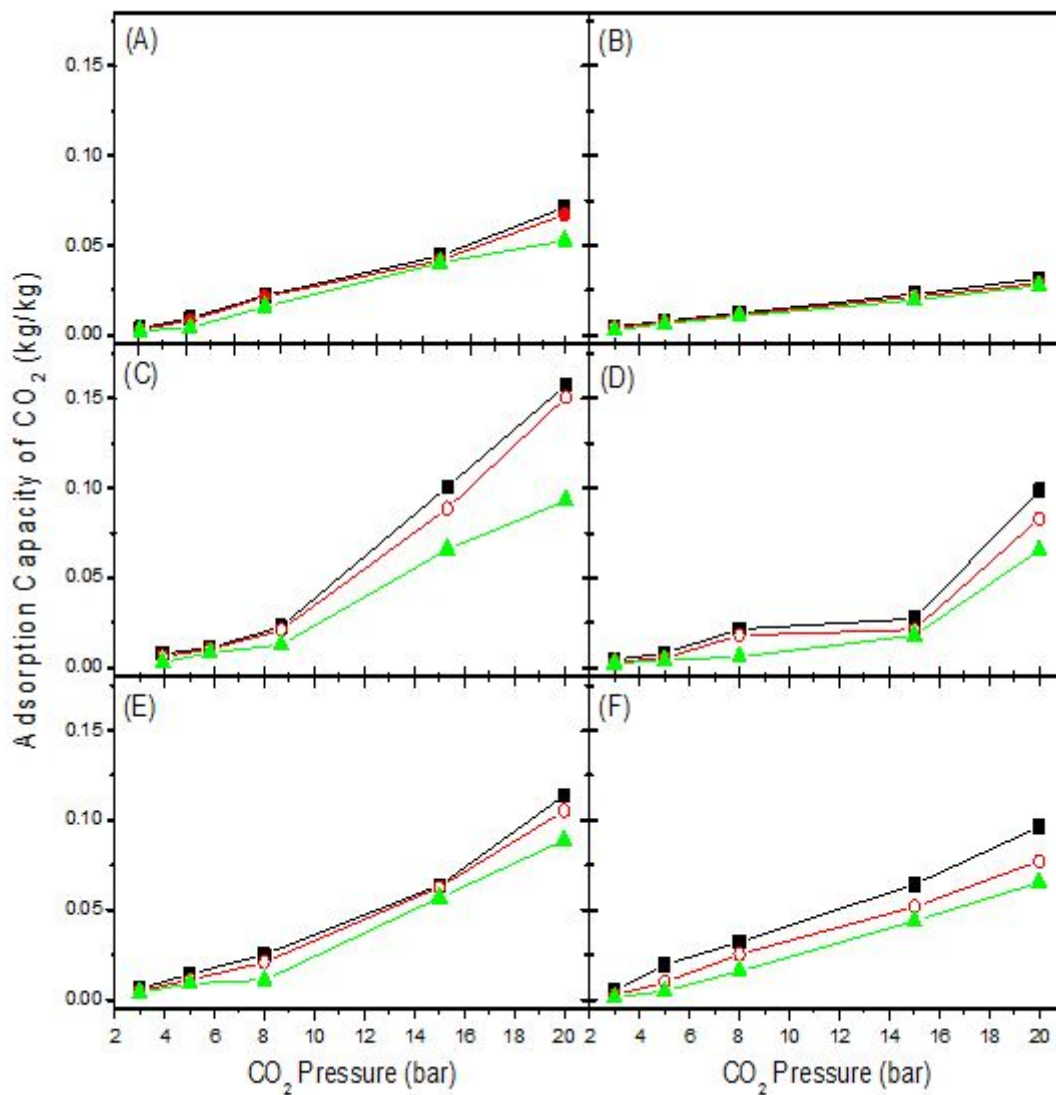

CO₂ Capture using Graphite Waste Composites and Ceria (<https://ijtech.eng.ui.ac.id/article/view/1031>)

Eny Kusriani, Chairani Utami, Anwar Usman, Nasruddin , Kevin Tito

Publication Date (Online):

Apr 27, 2018

DOI: <https://doi.org/10.14716/ijtech.v9i2.1031> (<https://doi.org/10.14716/ijtech.v9i2.1031>)

Pages : 287-296

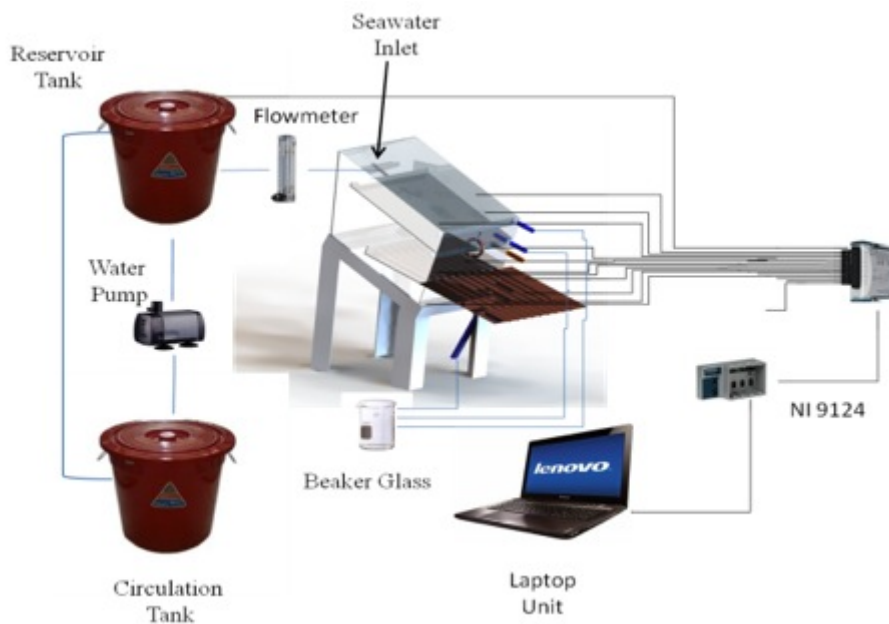

A New Cascade Solar Desalination System with Integrated Thermosyphons (<https://ijtech.eng.ui.ac.id/article/view/990>)

Mukhsinun Hadi Kusuma, Nandy Putra, Rizky Esa Respati

Publication Date (Online):

Apr 27, 2018

DOI: <https://doi.org/10.14716/ijtech.v9i2.990> (<https://doi.org/10.14716/ijtech.v9i2.990>)

Pages : 297-306

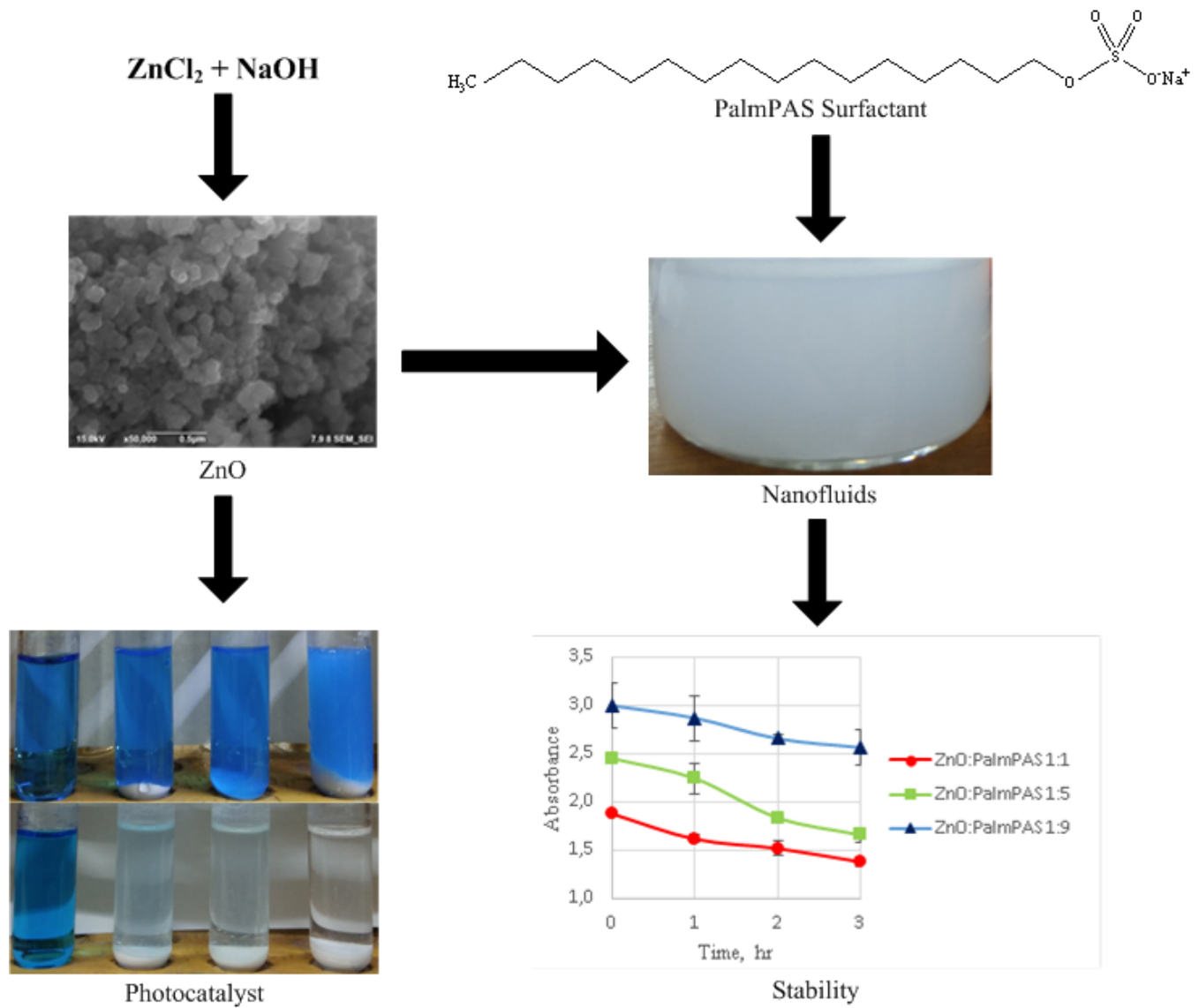

Synthesis of ZnO Nanoparticles and their Nanofluid Stability in the Presence of a Palm Oil-Based Primary Alkyl Sulphate Surfactant for Detergent Application
<https://ijtech.eng.ui.ac.id/article/view/1065>

Muhammad Triyogo Adiwibowo, Muhammad Ibadurrohman, Slamet

Publication Date (Online):

Apr 27, 2018

DOI: <https://doi.org/10.14716/ijtech.v9i2.1065> (<https://doi.org/10.14716/ijtech.v9i2.1065>)

Pages : 307-316

XRD patterns of the kaolin-fired ceramics showing the incorporation of metals into the structure.

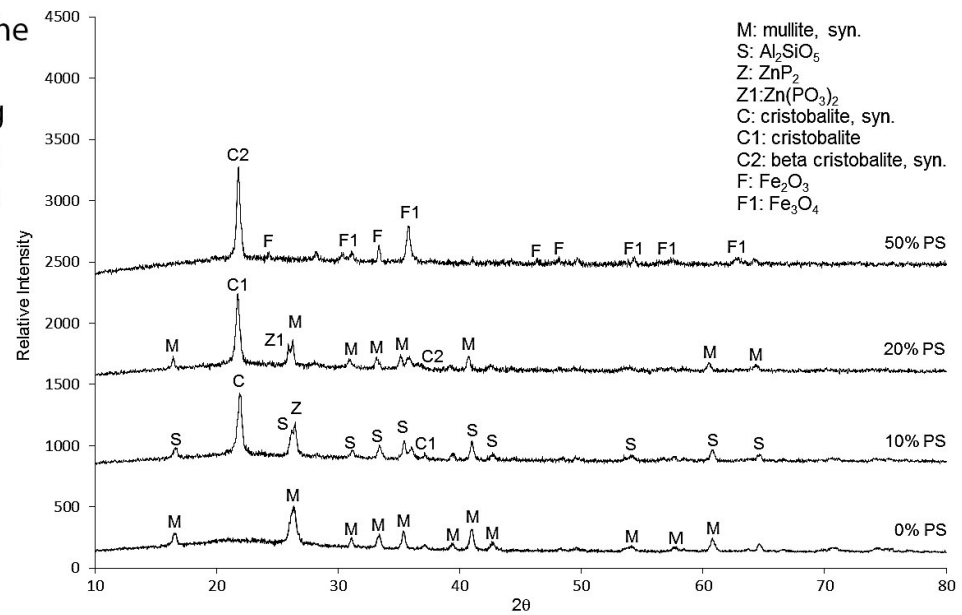

Preparation and Characterization of Phosphate-sludge Kaolin Mixture for Ceramics Bricks (<https://ijtech.eng.ui.ac.id/article/view/1119>)

Jackson Muliawan, Sotya Astutiningsih

Publication Date (Online):

Apr 27, 2018

DOI: <https://doi.org/10.14716/ijtech.v9i2.1119> (<https://doi.org/10.14716/ijtech.v9i2.1119>)

Pages : 317-324

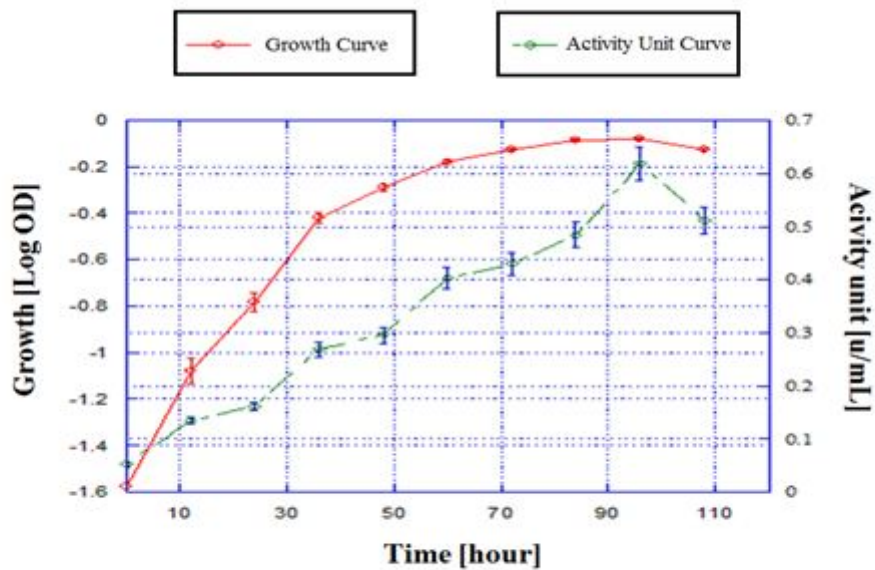

Figure 1 *Pseudomonas aeruginosa* growth (log OD) and lipase activity (u/mL) in POME

Production of Dry Extract Lipase from *Pseudomonas Aeruginosa* by the Submerged Fermentation Method in Palm Oil Mill Effluent

(<https://ijtech.eng.ui.ac.id/article/view/1511>)

Heri Hermansyah, Ambar Maresya, Dwini Normayulisa Putri, Muhamad Sahlan, Michel Meyer

Publication Date (Online):

Apr 27, 2018

DOI: <https://doi.org/10.14716/ijtech.v9i2.1511> (<https://doi.org/10.14716/ijtech.v9i2.1511>)

Pages : 325-334

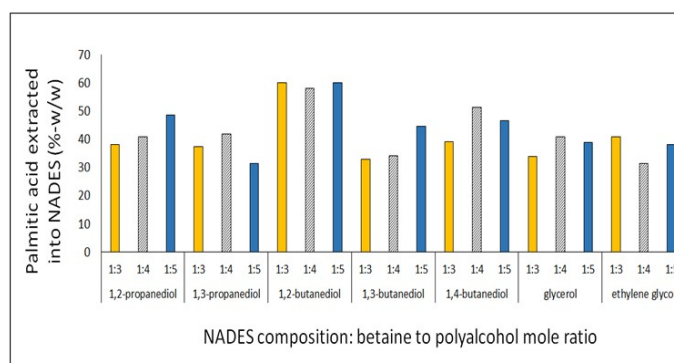
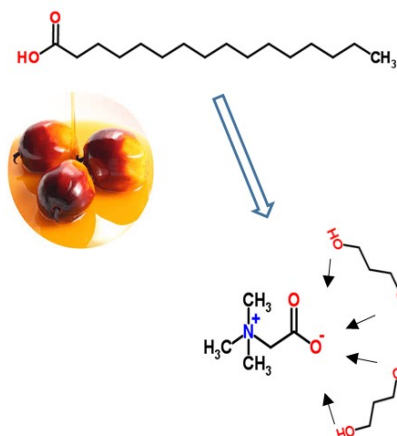

Green Extraction of Palmitic Acid from Palm Oil using Betaine-Based Natural Deep Eutectic Solvents (<https://ijtech.eng.ui.ac.id/article/view/1008>)

Kamarza Mulia, Dezaldi Adam, Ida Zahrina, Elsa Krisanti

Publication Date (Online):

Apr 27, 2018

DOI: <https://doi.org/10.14716/ijtech.v9i2.1008> (<https://doi.org/10.14716/ijtech.v9i2.1008>)

Pages : 335-344

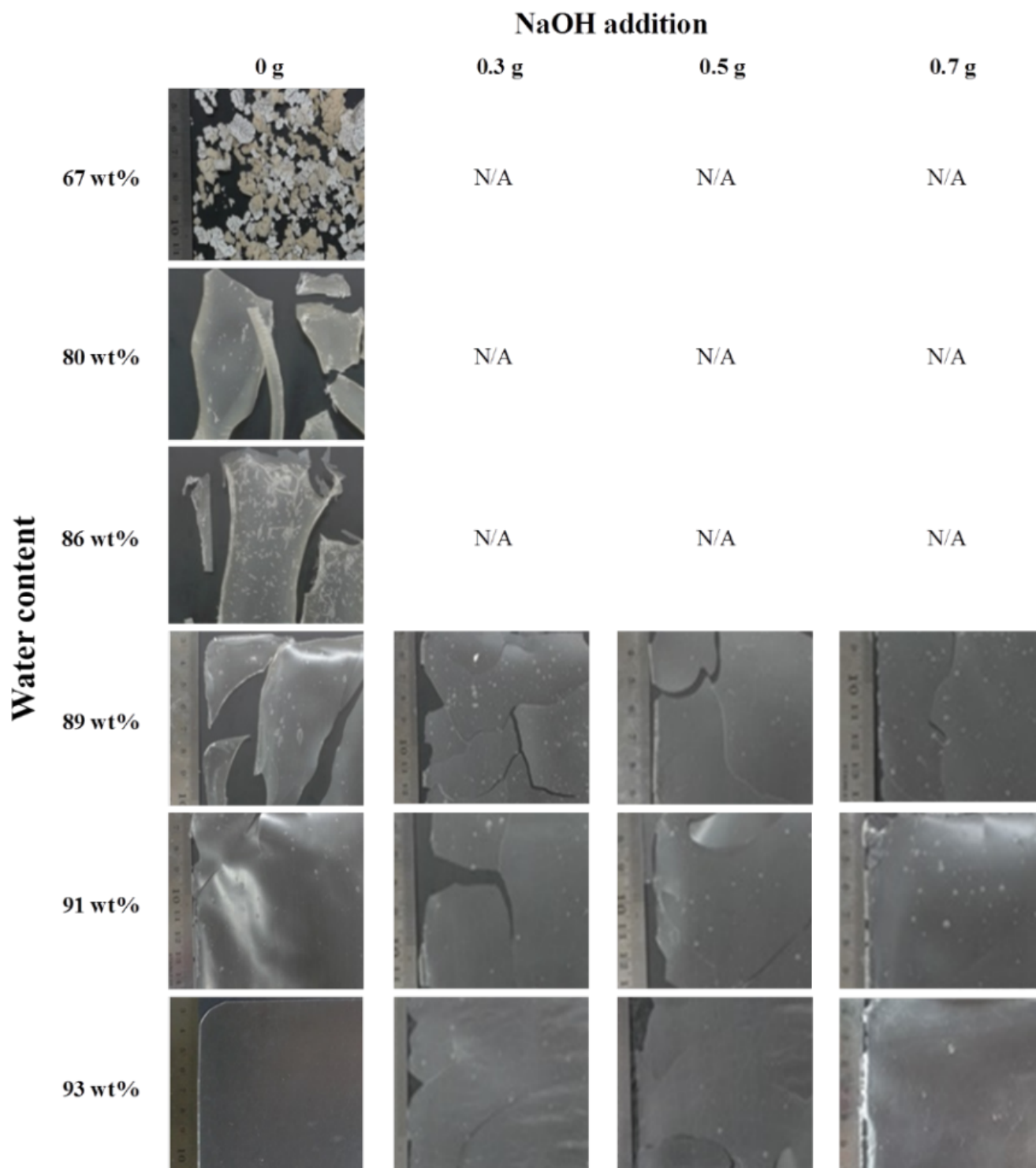

The Fabrication of Yam Bean (*Pachyrizous erosus*) Starch based Bioplastics (<https://ijtech.eng.ui.ac.id/article/view/1129>)

Hermawan Judawisastra, Ramona D.R. Sitohang, Dodi Ikhsan Taufiq, Mardiyati

Publication Date (Online):

Apr 27, 2018

DOI: <https://doi.org/10.14716/ijtech.v9i2.1129> (<https://doi.org/10.14716/ijtech.v9i2.1129>)

Pages : 345-352

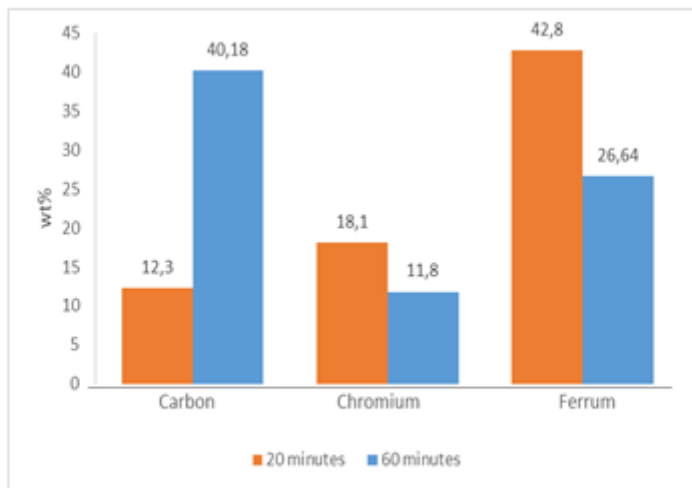

Fig. 6 EDX analysis in substrate 304 and 316 with extended of time synthesis

The Effect of Oxidative Heat Treatment on the Preparation of Stainless Steel 304 and 316 as the Effective Catalytic Substrate for Carbon Nanotube Growth (<https://ijtech.eng.ui.ac.id/article/view/1043>)

Praswasti Wulan , Yuni Lestari

Publication Date (Online):

Apr 27, 2018

DOI: <https://doi.org/10.14716/ijtech.v9i2.1043> (<https://doi.org/10.14716/ijtech.v9i2.1043>)

Pages : 353-363

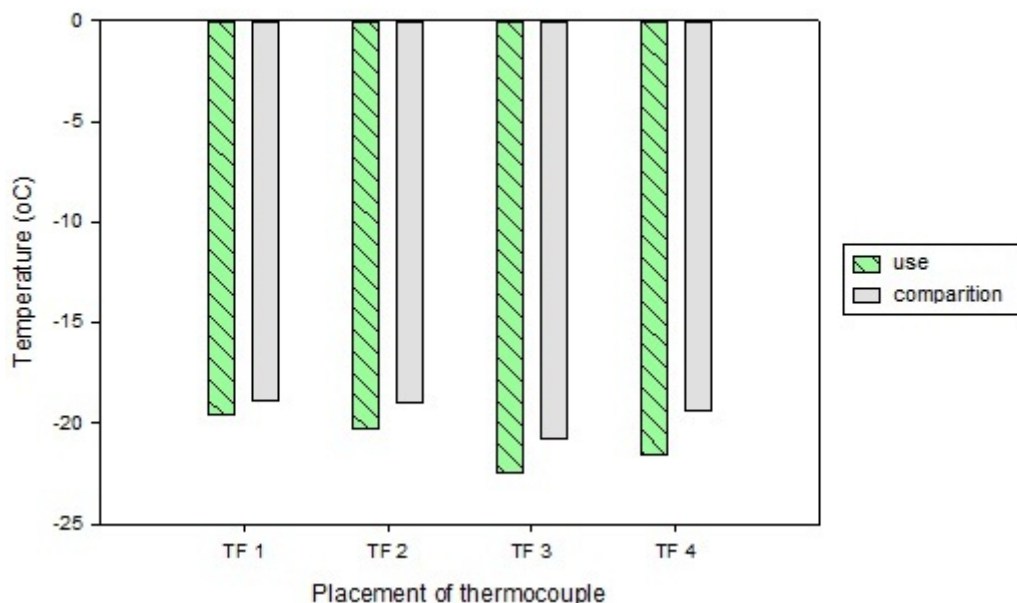

An Experimental Investigation into the Effect of Thermostat Settings on the Energy Consumption of Household Refrigerators (<https://ijtech.eng.ui.ac.id/article/view/1055>)

Edy Susanto, Muhammad Idrus, Nasruddin Nasruddin, Budihardjo Budihardjo

Publication Date (Online):

Apr 27, 2018

DOI: <https://doi.org/10.14716/ijtech.v9i2.1055> (<https://doi.org/10.14716/ijtech.v9i2.1055>)

Pages : 364-371

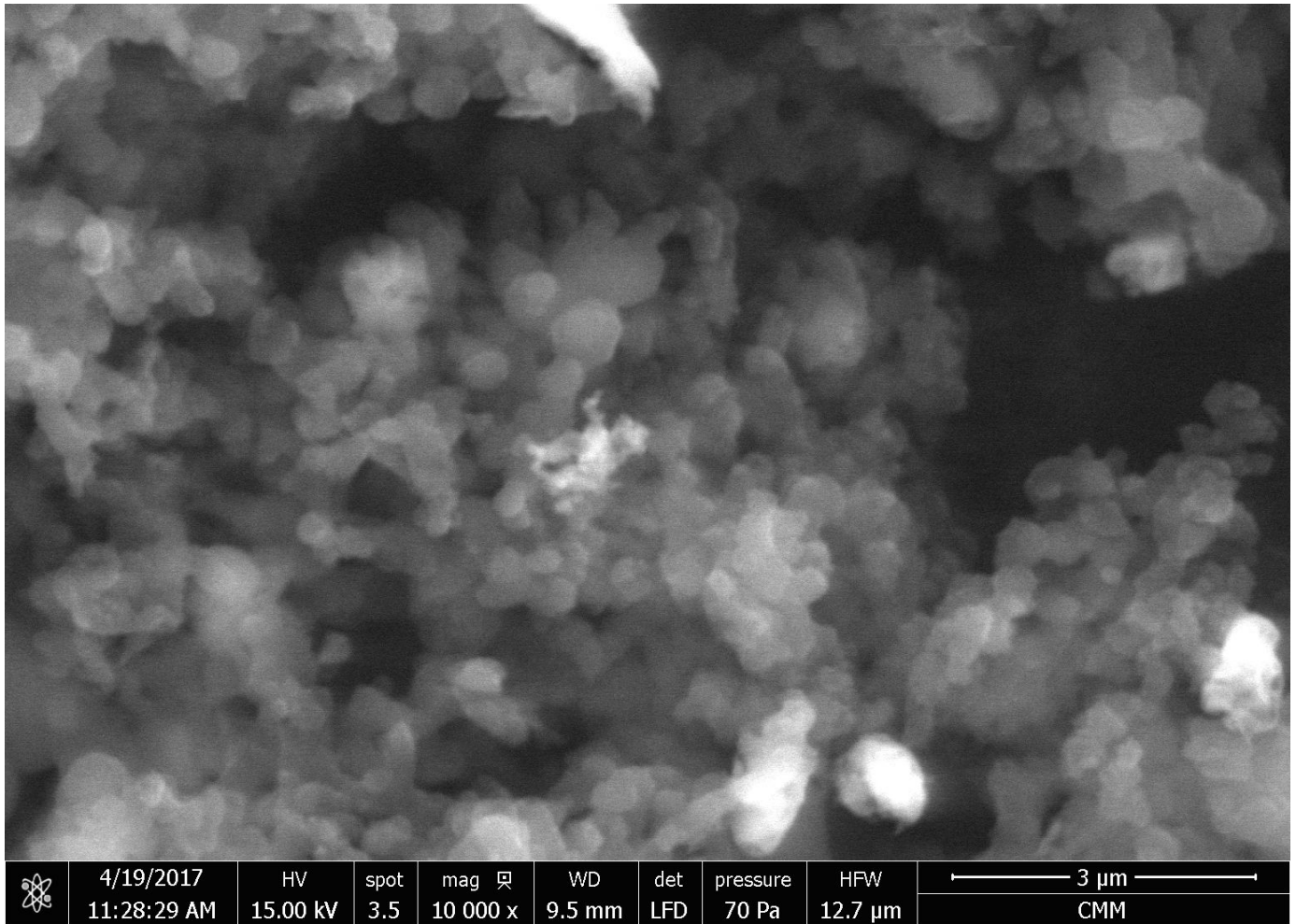

Characteristics of Carbon Pyrolyzed from Table Sugar and Sucrose for Pt-less DSSC Counter Electrode (<https://ijtech.eng.ui.ac.id/article/view/988>)

Nofrijon Sofyan, Muhammad , Aga Ridhova, Akhmad Herman Yuwono, Arief Udhiarto

Publication Date (Online):

Apr 27, 2018

DOI: <https://doi.org/10.14716/ijtech.v9i2.988> (<https://doi.org/10.14716/ijtech.v9i2.988>)

Pages : 372-379

The Effect of Papain Enzyme Dosage on the Modification of Egg-yolk Lecithin Emulsifier Product Through Enzymatic Hydrolysis Reaction

Setiadi, Nurul Hidayah¹
¹Chemical Engineering, Faculty of Engineering, 16424, Indonesia

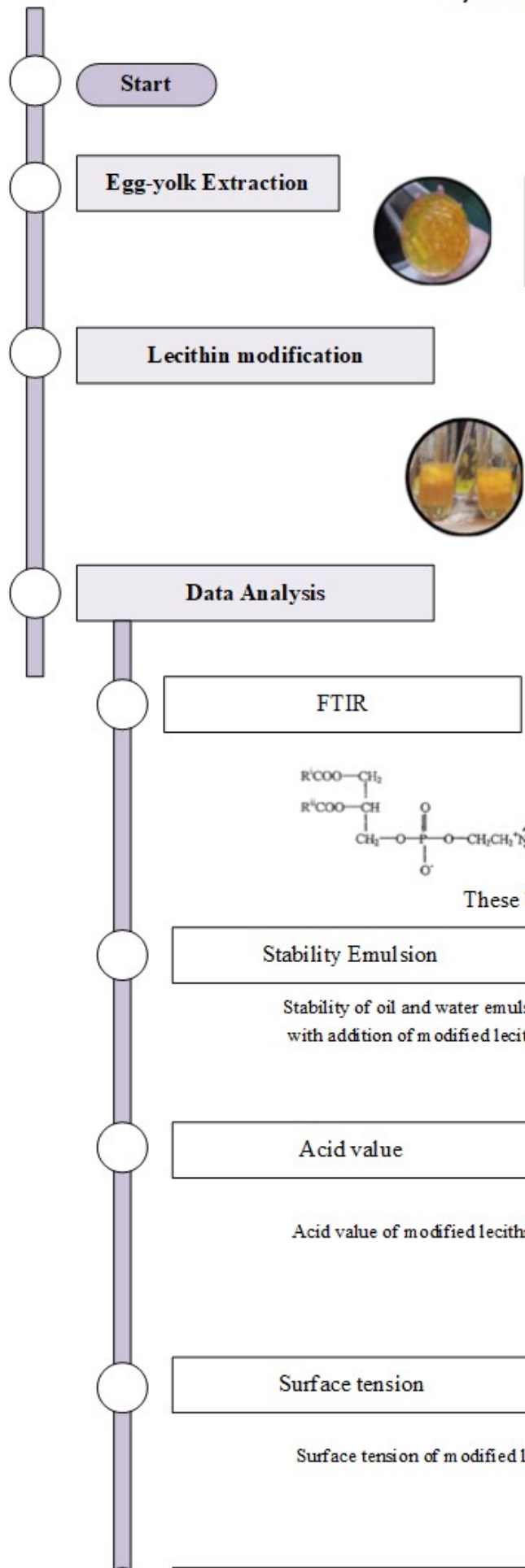

Start

Egg-yolk Extraction



Yield Crude Lecithin : 9.7%
 Yield of Purified Lecithin : 8.24%

Lecithin modification

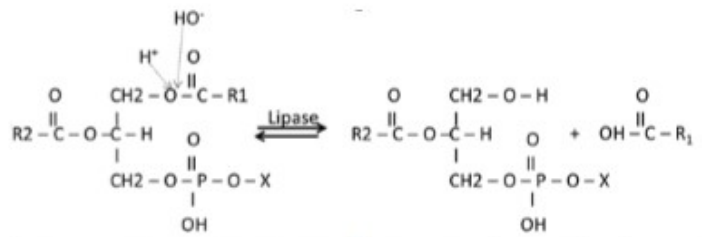

Data Analysis

FTIR

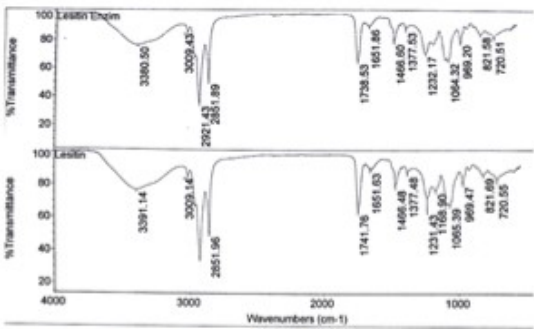
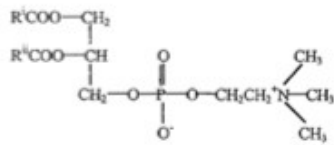

These bonds indicate the phosphatidylcholine

Stability Emulsion

Stability of oil and water emulsion with addition of modified lecithin

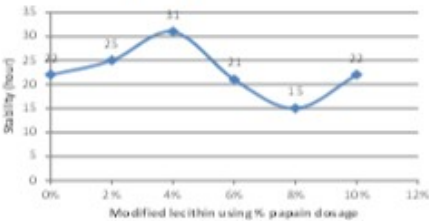

Acid value

Acid value of modified lecithin



Surface tension

Surface tension of modified lecithin

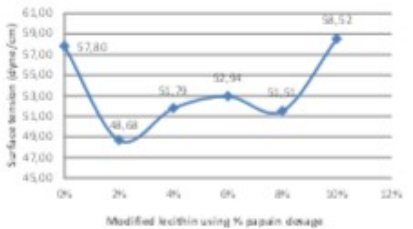

The Effect of Papain Enzyme Dosage on the Modification of Egg-yolk Lecithin Emulsifier Product through Enzymatic Hydrolysis Reaction

(<https://ijtech.eng.ui.ac.id/article/view/1073>)

Setiadi Setiadi, Nurul Hidayah

Modified Lecithin using 2% papain enzyme -94.8 mV

Publication Date (Online):

Apr 27, 2018

DOI: <https://doi.org/10.14716/ijtech.v9i2.1073> (<https://doi.org/10.14716/ijtech.v9i2.1073>)

Pages : 380-389

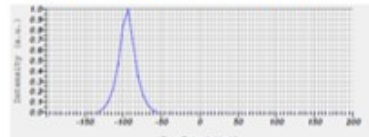
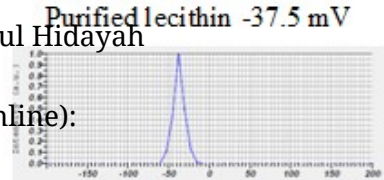

- (a) Reactor
- (b) Blower
- (c) Primary and Secondary Air Intake
- (d) Thermocouples
- (e) Filtering System
- (f) Burner
- (g) Data Logger

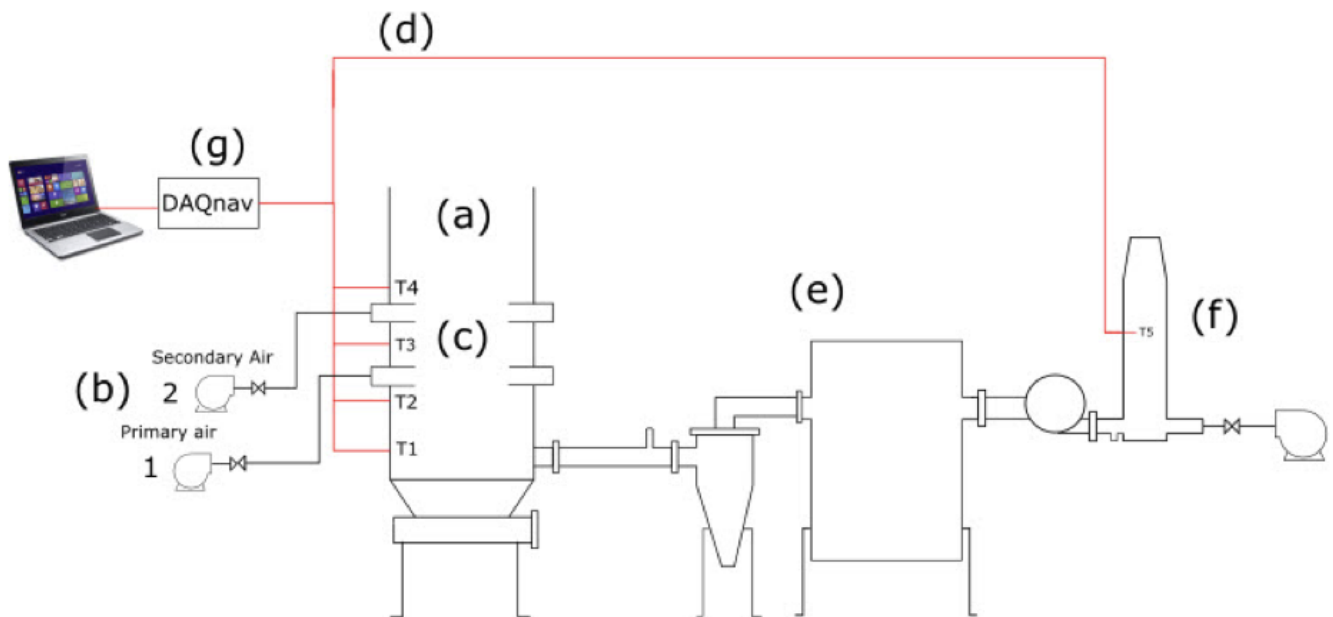

Optimization of Fixed Bed Downdraft Reactor for Rice Husk Biomass Gasification using Secondary Air Intake Variation (<https://ijtech.eng.ui.ac.id/article/view/1081>)

Felly Rihlat Gibran, Adi Surjosatyo, Andika Akbar Hermawan, Hafif Dafiqurrohman, Muhammad Barryl Anggriawan, Samsul Ma'arif, N.R. Yusuf

Publication Date (Online):

Apr 27, 2018

DOI: <https://doi.org/10.14716/ijtech.v9i2.1081> (<https://doi.org/10.14716/ijtech.v9i2.1081>)

Pages : 390-399

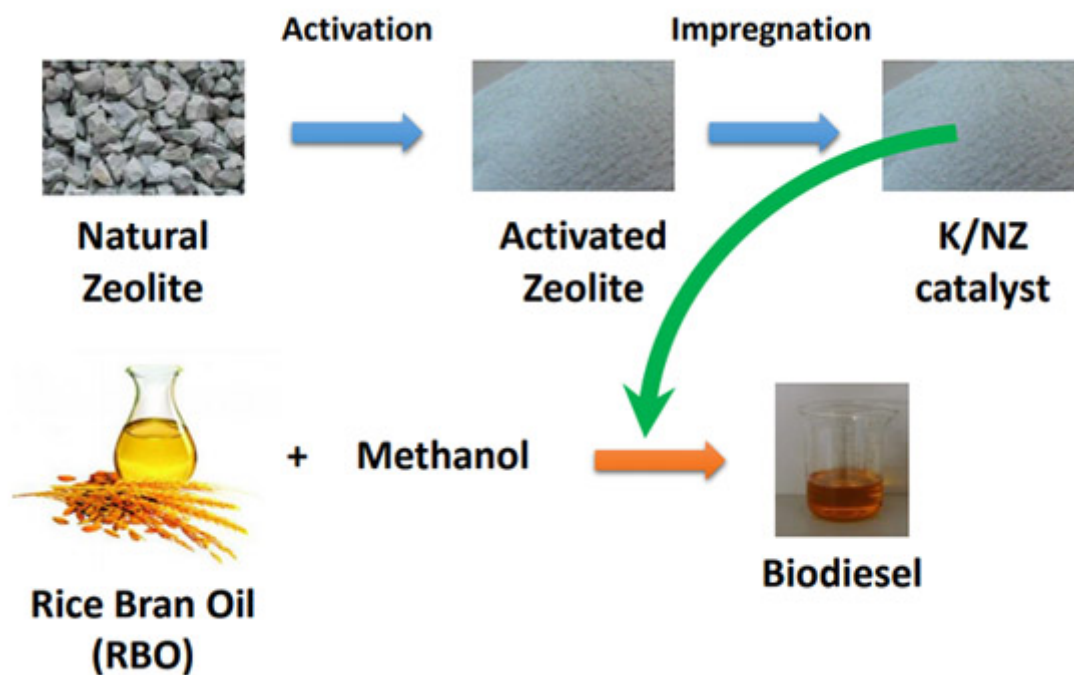

Biodiesel Production from Rice Bran Oil over Modified Natural Zeolite Catalyst (<https://ijtech.eng.ui.ac.id/article/view/1084>)

Arif Hidayat, Nur Indah Fajar Mukti, Bagus Handoko, Bachrun Sutrisno

Publication Date (Online):

Apr 27, 2018

DOI: <https://doi.org/10.14716/ijtech.v9i2.1084> (<https://doi.org/10.14716/ijtech.v9i2.1084>)

Pages : 400-411

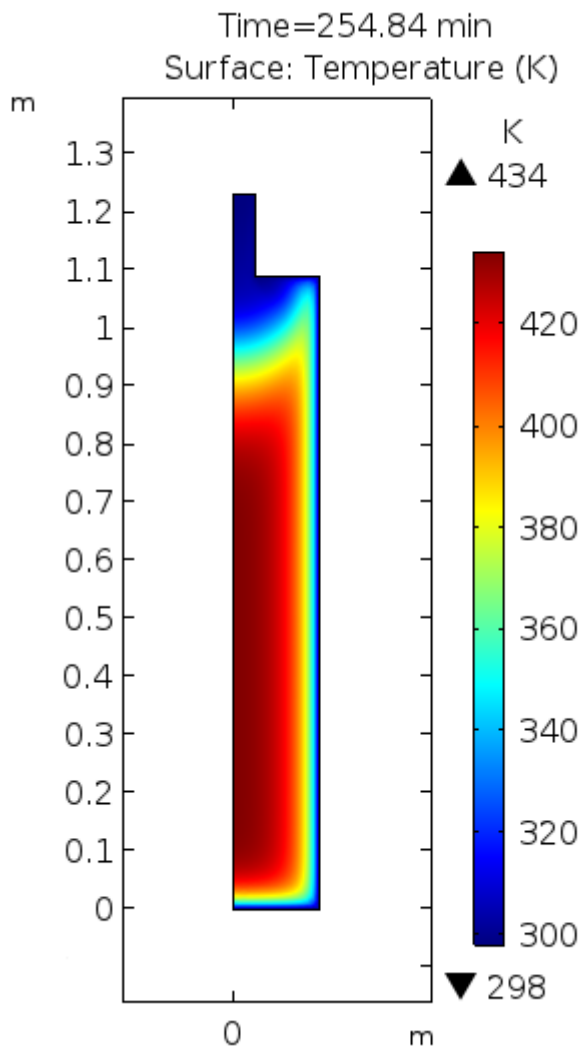

Simulation of a Metal Organic Framework-based Adsorbed Natural Gas Storage Tank (<https://ijtech.eng.ui.ac.id/article/view/1100>)

Yuswan Muharam, Eny Kusriani, Nurainia Saubryani, Maria Ulfa

Publication Date (Online):

Apr 27, 2018

DOI: <https://doi.org/10.14716/ijtech.v9i2.1100> (<https://doi.org/10.14716/ijtech.v9i2.1100>)

Pages : 412-421

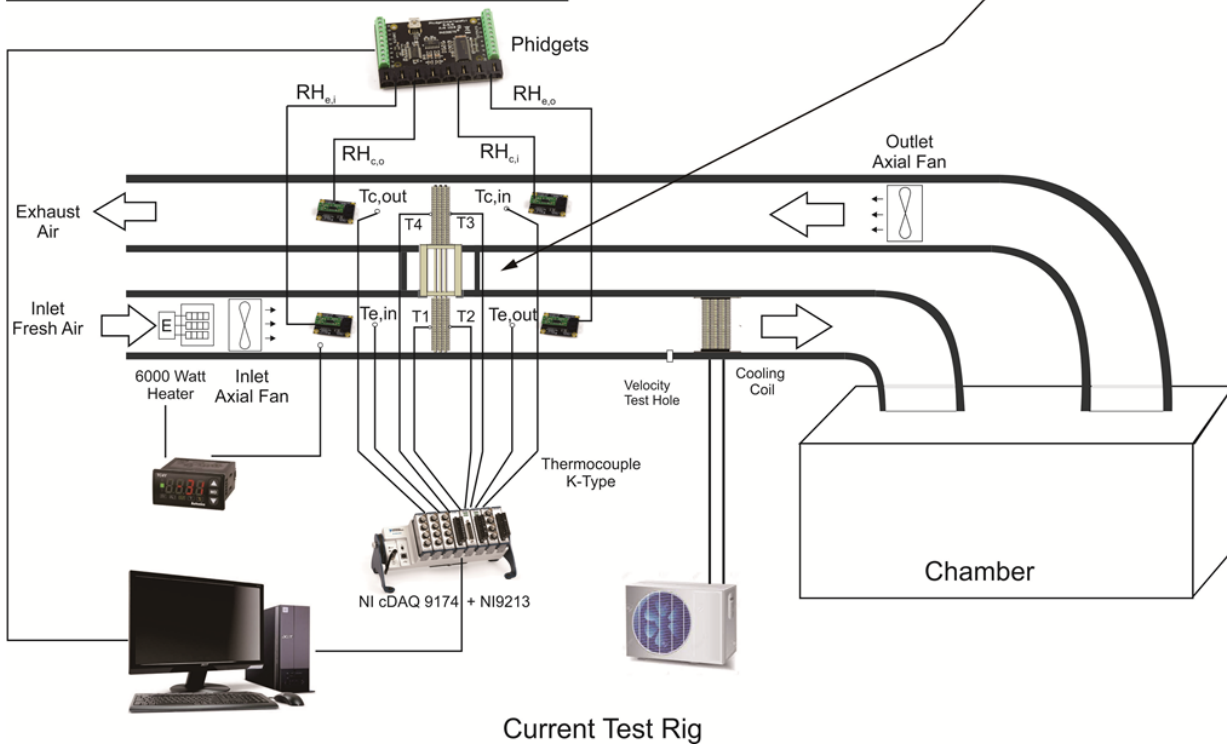
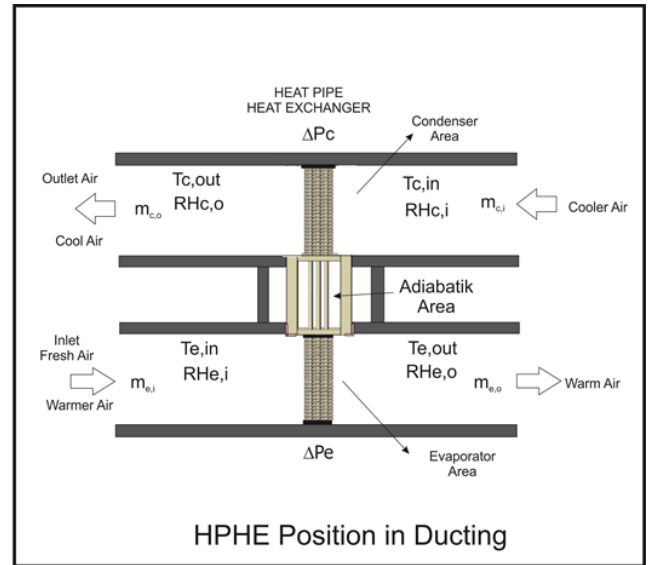
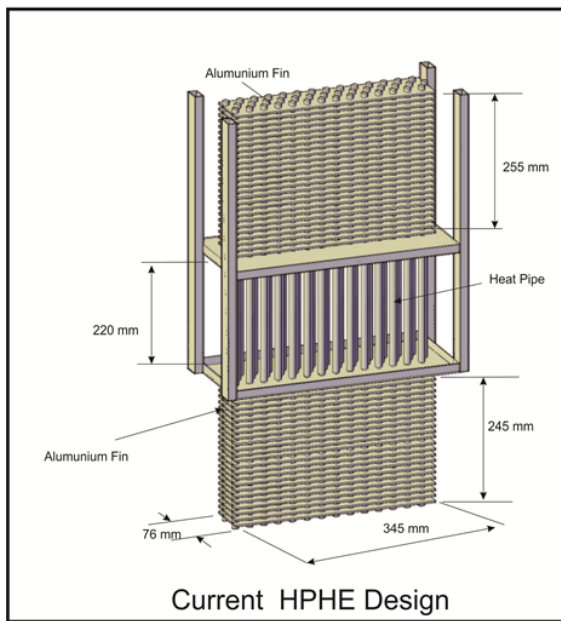

Experimental Study of Heat Pipe Heat Exchanger Multi Fin for Energy Efficiency Effort in Operating Room Air System (<https://ijtech.eng.ui.ac.id/article/view/1150>)

Syahrul Muhammadiyah, Adi Winarta, Nandy Putra

Publication Date (Online):

Apr 27, 2018

DOI: <https://doi.org/10.14716/ijtech.v9i2.1150> (<https://doi.org/10.14716/ijtech.v9i2.1150>)

Pages : 422-429

About the Journal

- Editorial Board (<https://ijtech.eng.ui.ac.id/people>)
- Focus and Scope (<https://ijtech.eng.ui.ac.id/about/5/focus-and-scope>)
- Online Submissions (<https://ijtech.eng.ui.ac.id/about/3/online-submission>)

- Publication Policy (<https://ijtech.eng.ui.ac.id/about/11/publication-policy>)
- Publication Ethics and Policy (<https://ijtech.eng.ui.ac.id/about/10/policy>)
- Author Guidelines (<https://ijtech.eng.ui.ac.id/about/4/author-guidelines>)
- List of Reviewers (<https://ijtech.eng.ui.ac.id/about/12>)

- Most downloaded papers (<https://ijtech.eng.ui.ac.id/home/mostdownloadedpapers>)
- Most cited papers (<https://ijtech.eng.ui.ac.id/about/14>)

🔒 Login

Username

Password

Not as user?

Register (<https://ijtech.eng.ui.ac.id/register>)

LOGIN

📖 IJTech

p-ISSN : 2086-9614 (<https://portal.issn.org/resource/ISSN/2086-9614>)

e-ISSN : 2087-2100 (<https://portal.issn.org/resource/ISSN/2087-2100>)

📈 Journal Metrics



(<https://www.scimagojr.com/journalsearch.php?q=21100235612&tip=sid&exact=no>)

Metrics by SCOPUS 2022

CiteScore 2021: **2.4**

CiteScoreTracker 2022: **2.0**

Source Normalized Impact per Paper
(SNIP): **0.744**

Acceptance rate: **18.50 %**

Average time to publish: **133 days.**

📈 IJTech is indexed in



(<https://www.scopus.com/sourceid/21100235612>)



(<http://www.ebsco.com/index.asp>)



(<https://doaj.org/toc/2086-9614>)



([https://www.scimagojr.com/journalsearch.php?](https://www.scimagojr.com/journalsearch.php?q=21100235612&tip=sid)

[q=21100235612&tip=sid](https://www.scimagojr.com/journalsearch.php?q=21100235612&tip=sid))



([https://journals.indexcopernicus.com/search/details?](https://journals.indexcopernicus.com/search/details?id=31340)

[id=31340](https://journals.indexcopernicus.com/search/details?id=31340))



(<http://www.crossref.org>)



([https://scholar.google.co.id/scholar?](https://scholar.google.co.id/scholar?q=site%3Ahttp%3A%2F%2Fijtech.eng.ui.ac.id)

[q=site%3Ahttp%3A%2F%2Fijtech.eng.ui.ac.id](https://scholar.google.co.id/scholar?q=site%3Ahttp%3A%2F%2Fijtech.eng.ui.ac.id))



(<https://mjl.clarivate.com:/search-results?issn=2086-9614>)

9614)



(<http://info.flagcounter.com/AoS7>)

Copyright © 2017 Faculty of Engineering
International Journal of Technology

IJTech secretariat, Engineering Center Bld., 2nd Fl.
Faculty of Engineering, Universitas Indonesia
Depok 16424, Indonesia.